

lineerled  
linearled

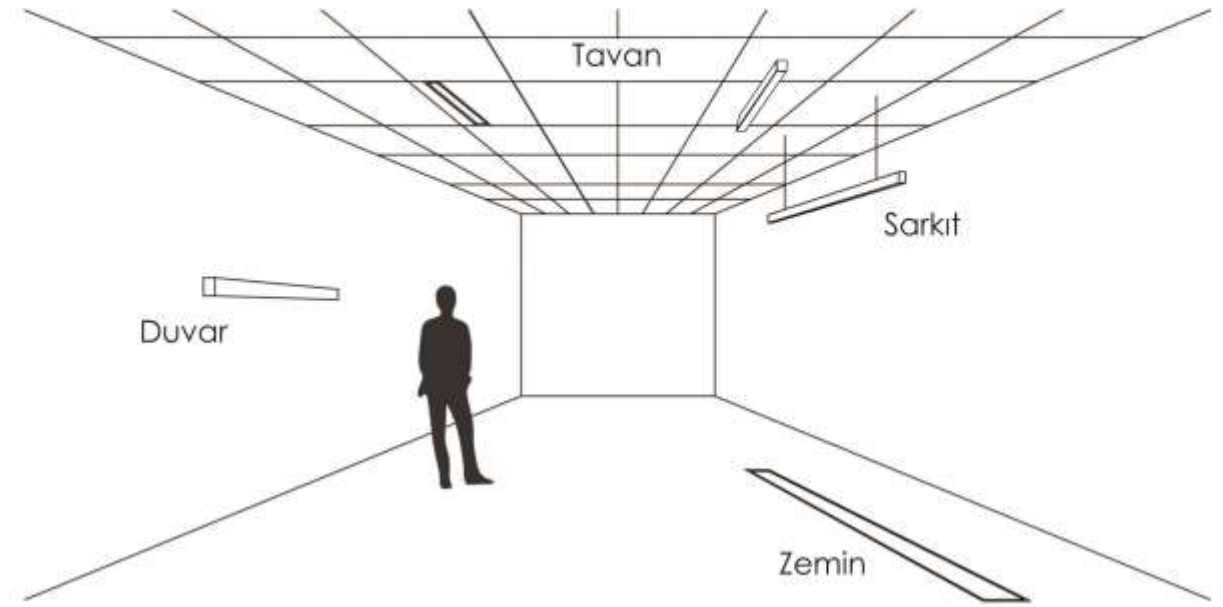

Esnek Planlar - Kesimler

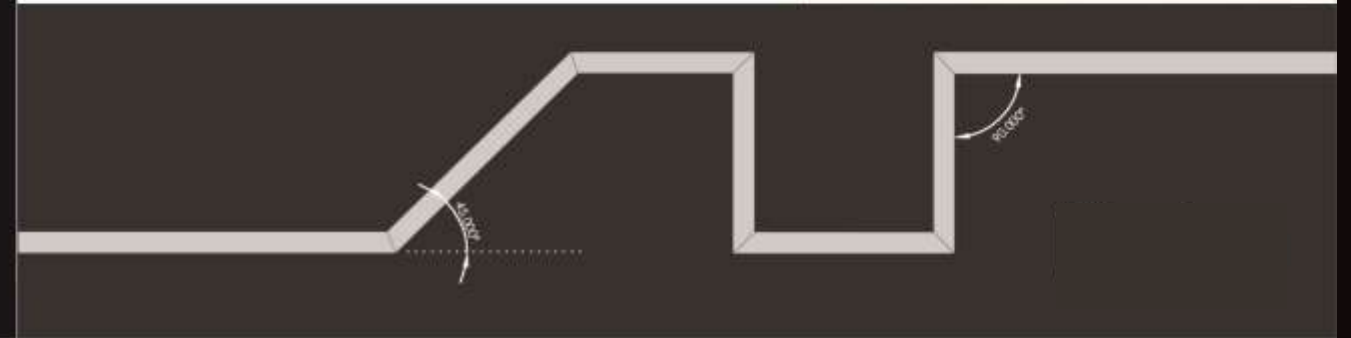
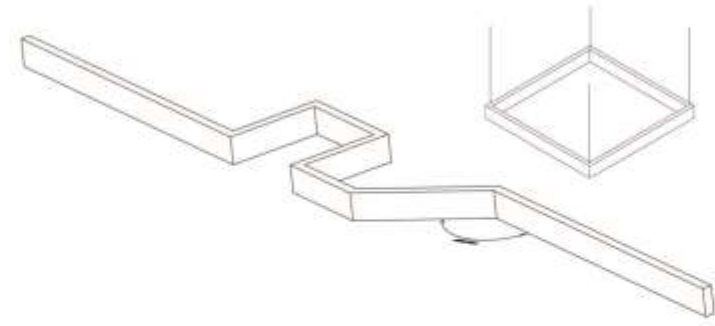

## lineerled / linearled



### Montaj / Mounting



### Bağlantı Opsiyonları Joiner Options

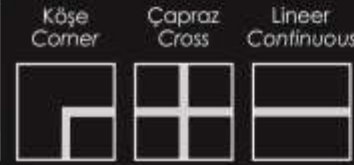

### Teknik Bilgiler / Technical Data

<b>Çalışma Gerilimi</b> Operating Voltage	85-260 V
<b>Güç / m</b> Power / m	28 W
<b>Işık Akısı / lm</b> Luminous flux	2000 lm
<b>Koruma</b> IP Grade	IP40 / IP65
<b>Işık Rengi</b> Lighting Color	2700 K 3000 K 4000 K 5000 K 6500 K RGB
<b>Yüzey Dokusu</b> Surface appearance	Mat, Parlak, Satine Matt, Polished, Satine
<b>Renk Seçenekleri</b> Color Options	Tüm Alüminyum Eloksal Renkleri / All colors of electro - anodizing Tüm Elektrostatik Toz Boya Renkleri / All colors of electrostatic powder coating Tüm Ahşap Desenleri / All types of wood patterns
<b>Kontrol Seçenekleri</b> Controler Options	DALI, DIM (0-10 V, PWM, Resistor, Triac, Touch)
<b>Çalışma Sıcaklığı</b> Working Temperature	-25°C - +45°C

## Ln20 serisi / series

## Ln2020 - Ln2040

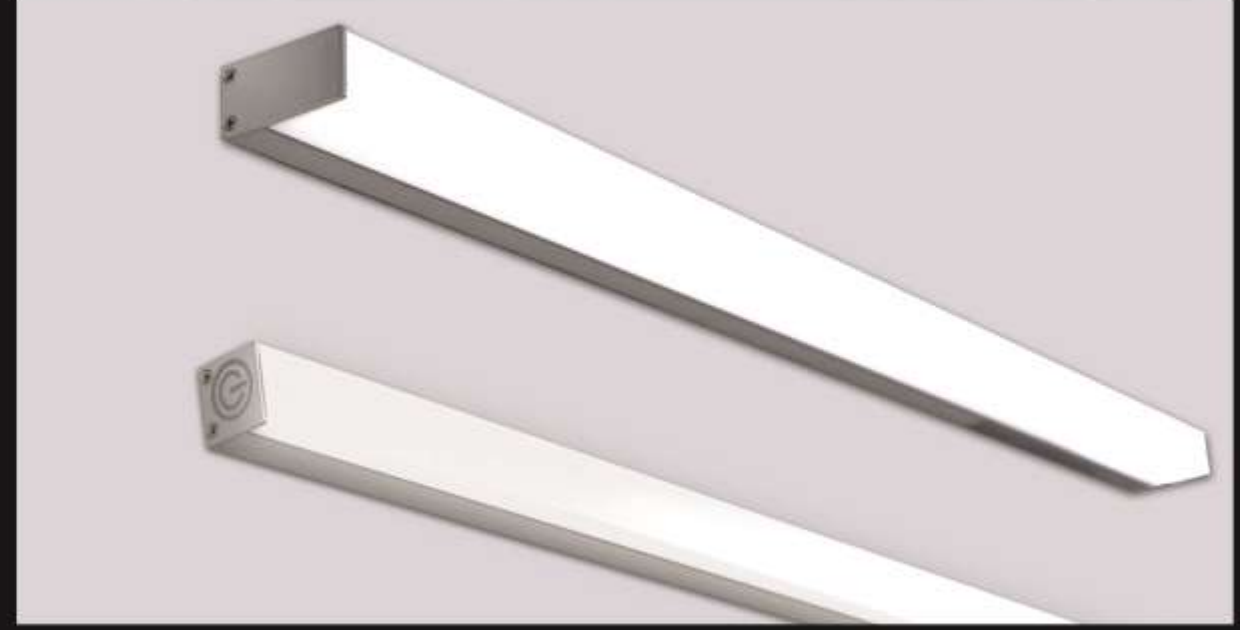

### Boyutlar / Dimensions

Uzunluk / Length:  
600mm, 1200mm, 3000mm

\*Özel ölçü üretilebilir. (max. 6000 mm)  
\*Custom production. (max. 6000 mm)

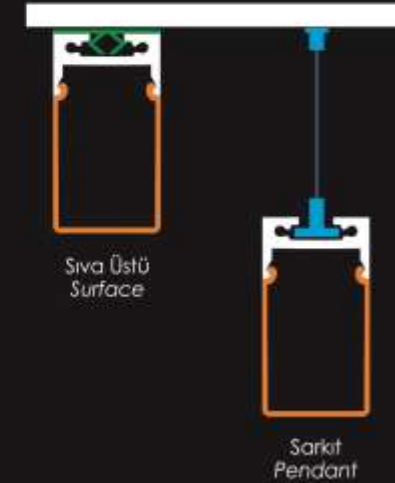
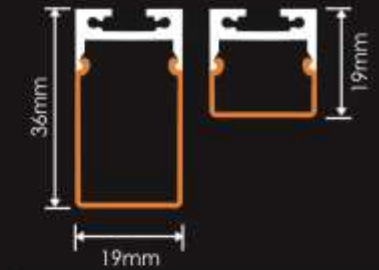

## lineerled / linearled



### Montaj / Mounting



### Bağlantı Opsiyonları Joiner Options

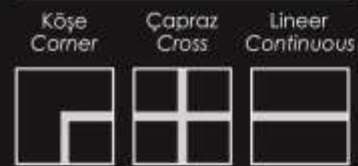

### Teknik Bilgiler / Technical Data

<b>Çalışma Gerilimi</b> Operating Voltage	85-260 V
<b>Güç / m</b> Power / m	10 W   20 W   32 W   64 W
<b>Işık Akısı / lm</b> Luminous flux	1000 lm   2000 lm   4000 lm   7500 lm
<b>Koruma</b> IP Grade	IP20/IP68   IP20/IP68   IP20   IP20
<b>Işık Rengi</b> Lighting Color	 2700 K   3000 K   4000 K   5000 K   6500 K   RGB
<b>Yüzey Dokusu</b> Surface appearance	Mat, Parlak, Satine Matt, Polished, Satine
<b>Renk Seçenekleri</b> Color Options	Tüm Alüminyum Eloksal Renkleri / All colors of electro - anodizing Tüm Elektrostatik Toz Boya Renkleri / All colors of electrostatic powder coating Tüm Ahşap Desenleri / All types of wood patterns
<b>Kontrol Seçenekleri</b> Controler Options	DALI, DIM (0-10 V, PWM, Resistor, Triac, Touch)
<b>Çalışma Sıcaklığı</b> Working Temperature	-25°C - +45°C

## Ln35 serisi / series

Ln3560- Ln3570



### Boyutlar / Dimensions

Uzunluk / Length:  
600mm, 1200mm, 3000mm

\*Özel ölçü üretilebilir. (max. 6000 mm)  
\*Custom production. (max. 6000 mm)

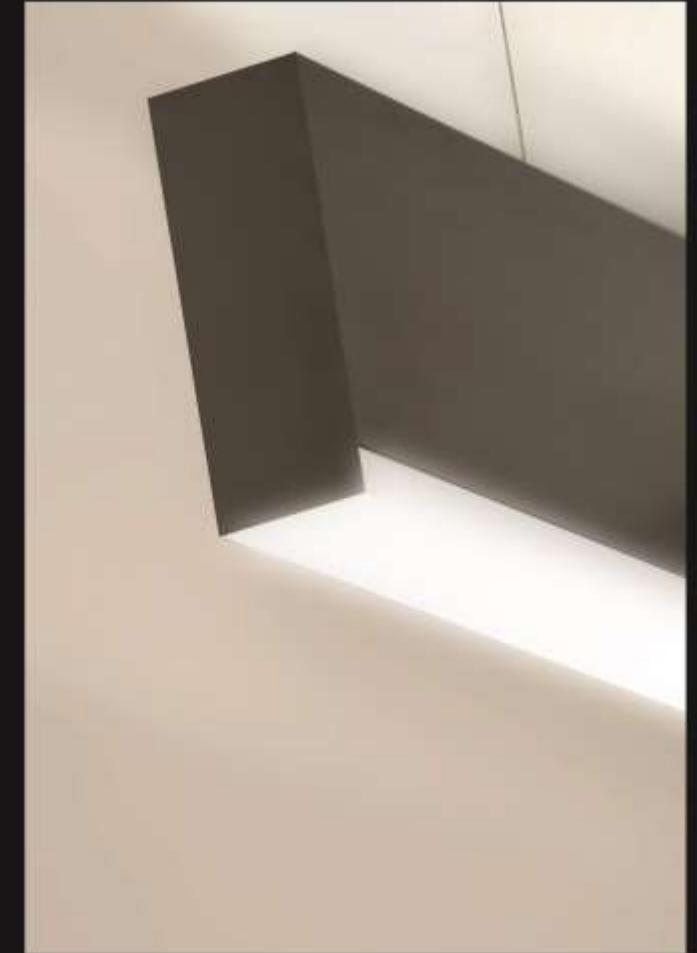
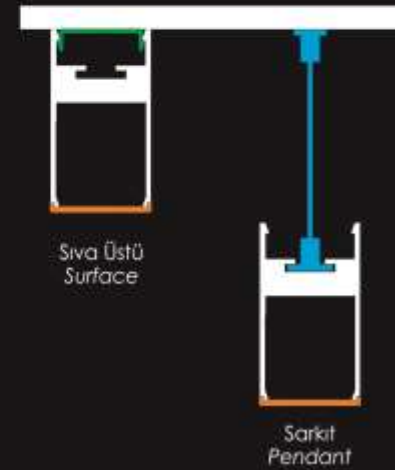
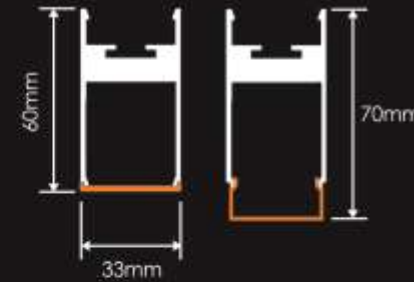



## lineerled / linearled



### Montaj / Mounting



### Bağlantı Opsiyonları Joiner Options

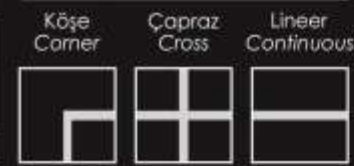

### Teknik Bilgiler / Technical Data

<b>Çalışma Gerilimi</b> Operating Voltage	85-260 V
<b>Güç / m</b> Power / m	10 W   20 W   32 W   64 W
<b>Işık Akısı / lm</b> Luminous flux	1000 lm   2000 lm   4000 lm   7500 lm
<b>Koruma</b> IP Grade	IP20/IP68   IP20/IP68   IP20   IP20
<b>Işık Rengi</b> Lighting Color	2700 K   3000 K   4000 K   5000 K   6500 K   RGB
<b>Yüzey Dokusu</b> Surface appearance	Mat, Parlak, Satine Matt, Polished, Satine
<b>Renk Seçenekleri</b> Color Options	Tüm Alüminyum Eloksal Renkleri / All colors of electro-anodizing Tüm Elektrostatik Toz Boya Renkleri / All colors of electrostatic powder coating Tüm Ahşap Desenleri / All types of wood patterns
<b>Kontrol Seçenekleri</b> Controler Options	DALI, DIM (0-10 V, PWM, Resistor, Triac, Touch)
<b>Çalışma Sıcaklığı</b> Working Temperature	-25°C - +45°C

## Ln50 serisi / series

Ln50120- Ln51135



### Boyutlar / Dimensions

Uzunluk / Length:  
600mm, 1200mm, 3000mm

\*Özel ölçü üretilebilir. (max. 6000 mm)  
\*Custom production. (max. 6000 mm)

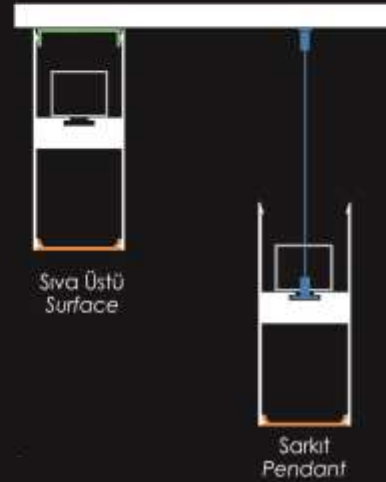
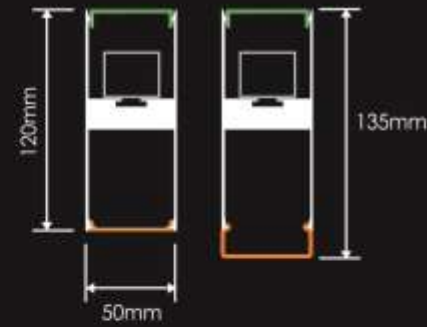



## lineerled / linearled



### Montaj / Mounting



### Bağlantı Opsiyonları Joiner Options

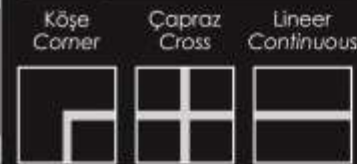

### Teknik Bilgiler / Technical Data

<b>Çalışma Gerilimi</b> Operating Voltage	85-260 V
<b>Güç / m</b> Power / m	10 W   20 W   32 W   64 W
<b>Işık Akısı / lm</b> Luminous flux	1000 lm   2000 lm   4000 lm   7500 lm
<b>Koruma</b> IP Grade	IP20/IP68   IP20/IP68   IP20   IP20
<b>Işık Rengi</b> Lighting Color	 2700 K   3000 K   4000 K   5000 K   6500 K   RGB
<b>Yüzey Dokusu</b> Surface appearance	Mat, Parlak, Satine Matt, Polished, Satine
<b>Renk Seçenekleri</b> Color Options	Tüm Alüminyum Eloksal Renkleri / All colors of electro - anodizing Tüm Elektrostatik Toz Boya Renkleri / All colors of electrostatic powder coating Tüm Ahşap Desenleri / All types of wood patterns
<b>Kontrol Seçenekleri</b> Controler Options	DALI, DIM (0-10 V, PWM, Resistor, Triac, Touch)
<b>Çalışma Sıcaklığı</b> Working Temperature	-25°C - +45°C

## Ln50 serisi / series

Ln50100- Ln51115



### Boyutlar / Dimensions

Uzunluk / Length:  
600mm, 1200mm, 3000mm

\*Özel ölçü üretilebilir. (max. 6000 mm)  
\*Custom production.(max. 6000 mm)

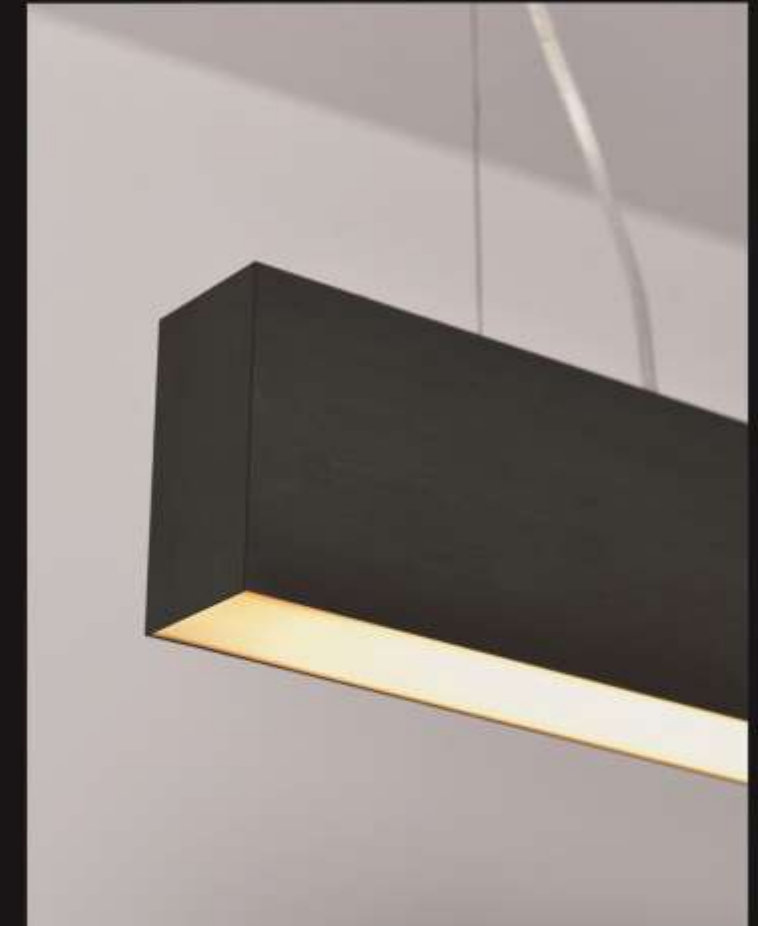
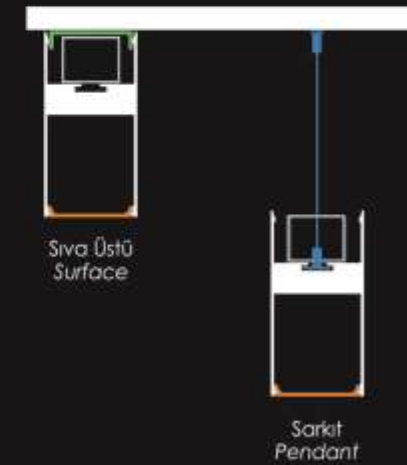
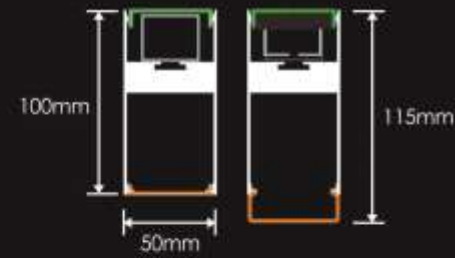

## lineerled / linearled



### Montaj / Mounting



### Bağlantı Opsiyonları Joiner Options

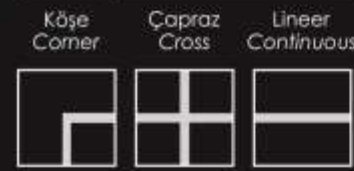

### Teknik Bilgiler / Technical Data

<b>Çalışma Gerilimi</b> Operating Voltage	85-260 V
<b>Güç / m</b> Power / m	10 W   20 W   32 W   64 W
<b>Işık Akısı / lm</b> Luminous flux	1000 lm   2000 lm   4000 lm   7500 lm
<b>Koruma</b> IP Grade	IP20/IP68   IP20/IP68   IP20   IP20
<b>Işık Rengi</b> Lighting Color	 2700 K   3000 K   4000 K   5000 K   6500 K   RGB
<b>Yüzey Dokusu</b> Surface appearance	Mat, Parlak, Satine Matt, Polished, Satine
<b>Renk Seçenekleri</b> Color Options	Tüm Alüminyum Eloksal Renkleri / All colors of electro - anodizing Tüm Elektrostatik Toz Boya Renkleri / All colors of electrostatic powder coating Tüm Ahşap Desenleri / All types of wood patterns
<b>Kontrol Seçenekleri</b> Controler Options	DALI, DIM (0-10 V, PWM, Resistor, Triac, Touch)
<b>Çalışma Sıcaklığı</b> Working Temperature	-25°C - +45°C

## Ln50 serisi / series

Ln5085- Ln51100



### Boyutlar / Dimensions

Uzunluk / Length:  
600mm, 1200mm, 3000mm

\*Özel ölçü üretilebilir. (max. 6000 mm)  
\*Custom production.(max. 6000 mm)

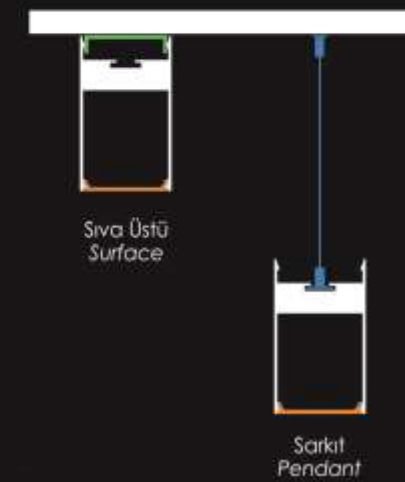
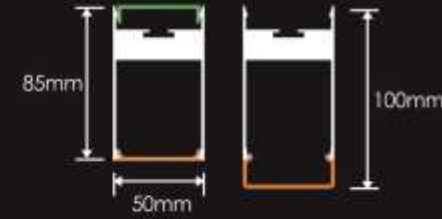

## lineerled / linearled



### Montaj / Mounting



### Bağlantı Opsiyonları Joiner Options

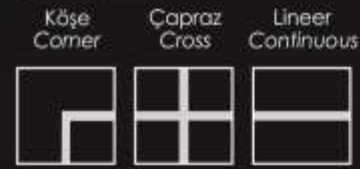

### Teknik Bilgiler / Technical Data

<b>Çalışma Gerilimi</b> Operating Voltage	85-260 V
<b>Güç / m</b> Power / m	10 W   20 W   32 W   64 W
<b>Işık Akısı / lm</b> Luminous flux	1000 lm   2000 lm   4000 lm   7500 lm
<b>Koruma</b> IP Grade	IP20/IP68   IP20/IP68   IP20   IP20
<b>Işık Rengi</b> Lighting Color	 2700 K   3000 K   4000 K   5000 K   6500 K   RGB
<b>Yüzey Dokusu</b> Surface appearance	Mat, Parlak, Satine Matt, Polished, Satine
<b>Renk Seçenekleri</b> Color Options	Tüm Alüminyum Eloksal Renkleri / All colors of electro - anodizing Tüm Elektrostatik Toz Boya Renkleri / All colors of electrostatic powder coating Tüm Ahşap Desenleri / All types of wood patterns
<b>Kontrol Seçenekleri</b> Controler Options	DALI, DIM (0-10 V, PWM, Resistor, Triac, Touch)
<b>Çalışma Sıcaklığı</b> Working Temperature	-25°C - +45°C

## Ln50 serisi / series

Ln5072- Ln5187



### Boyutlar / Dimensions

Uzunluk / Length:  
600mm, 1200mm, 3000mm

\*Özel ölçü üretilebilir. (max. 6000 mm)  
\*Custom production.(max. 6000 mm)

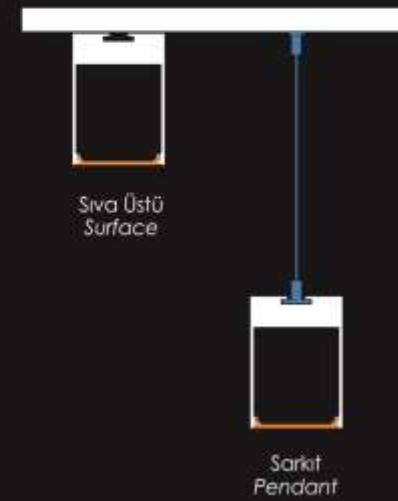
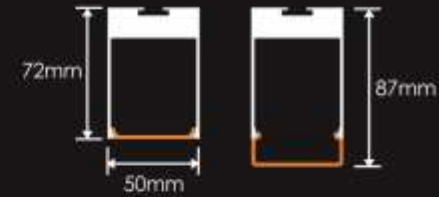



## lineerled / linearled



### Montaj / Mounting



### Bağlantı Opsiyonları Joiner Options

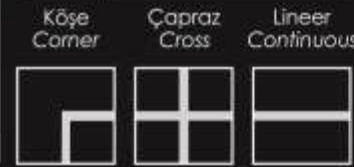

### Teknik Bilgiler / Technical Data

<b>Çalışma Gerilimi</b> Operating Voltage	85-260 V
<b>Güç / m</b> Power / m	10 W   20 W   32 W   64 W
<b>Işık Akısı / lm</b> Luminous flux	1000 lm   2000 lm   4000 lm   7500 lm
<b>Koruma</b> IP Grade	IP20/IP68   IP20/IP68   IP20   IP20
<b>Işık Rengi</b> Lighting Color	2700 K   3000 K   4000 K   5000 K   6500 K   RGB
<b>Yüzey Dokusu</b> Surface appearance	Mat, Parlak, Satine Matt, Polished, Satine
<b>Renk Seçenekleri</b> Color Options	Tüm Alüminyum Eloksal Renkleri / All colors of electro - anodizing Tüm Elektrostatik Toz Boya Renkleri / All colors of electrostatic powder coating Tüm Ahşap Desenleri / All types of wood patterns
<b>Kontrol Seçenekleri</b> Controler Options	DALI, DIM (0-10 V, PWM, Resistor, Triac, Touch)
<b>Çalışma Sıcaklığı</b> Working Temperature	-25°C - +45°C

## Ln50 serisi / series

Ln5057- Ln5172



### Boyutlar / Dimensions

Uzunluk / Length:  
600mm, 1200mm, 3000mm

\*Özel ölçü üretilebilir. (max. 6000 mm)  
\*Custom production. (max. 6000 mm)

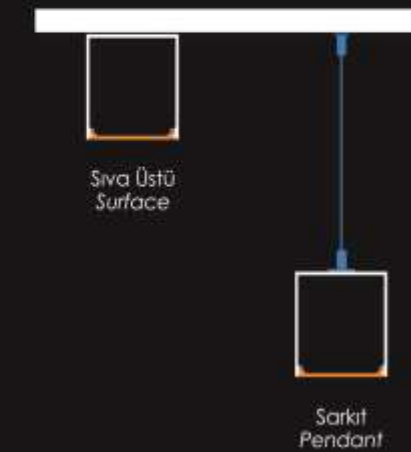
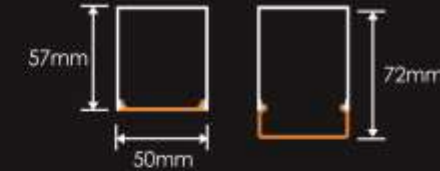

## lineerled / linearled



### Montaj / Mounting



### Bağlantı Opsiyonları Joiner Options

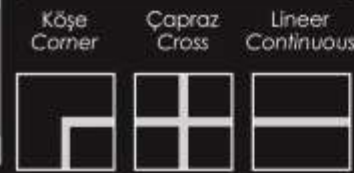

### Teknik Bilgiler / Technical Data

<b>Çalışma Gerilimi</b> Operating Voltage	85-260 V
<b>Güç / m</b> Power / m	20 W   40 W   64 W   128 W
<b>Işık Akısı / lm</b> Luminous flux	2000 lm   4000 lm   8000 lm   15000 lm
<b>Koruma</b> IP Grade	IP20/IP68   IP20/IP68   IP20   IP20
<b>Işık Rengi</b> Lighting Color	 2700 K   3000 K   4000 K   5000 K   6500 K   RGB
<b>Yüzey Dokusu</b> Surface appearance	Mat, Parlak, Satine Matt, Polished, Satine
<b>Renk Seçenekleri</b> Color Options	Tüm Alüminyum Eloksal Renkleri / All colors of electro-anodizing Tüm Elektrostatik Toz Boya Renkleri / All colors of electrostatic powder coating Tüm Ahşap Desenleri / All types of wood patterns
<b>Kontrol Seçenekleri</b> Controler Options	DALI, DIM (0-10 V, PWM, Resistor, Triac, Touch)
<b>Çalışma Sıcaklığı</b> Working Temperature	-25°C - +45°C

## Ln50 serisi / series

Ln50185



### Boyutlar / Dimensions

Uzunluk / Length:  
600mm, 1200mm, 3000mm

\*Özel ölçü üretilebilir. (max. 6000 mm)  
\*Custom production. (max. 6000 mm)

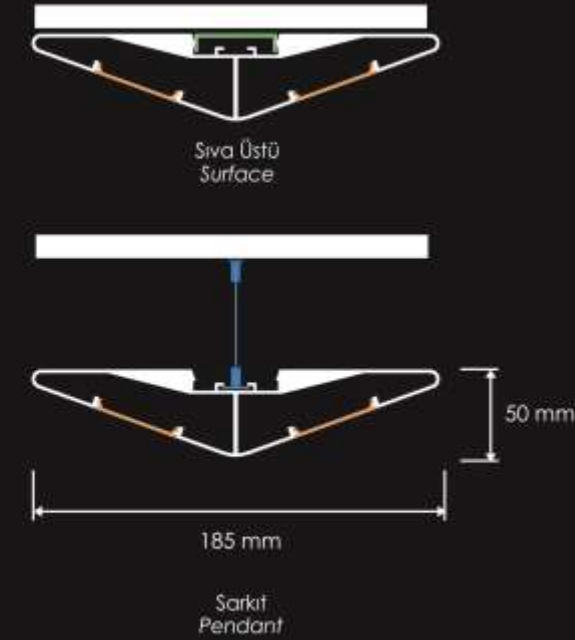



## lineerled / linearled



### Montaj / Mounting



### Bağlantı Opsiyonları Joiner Options

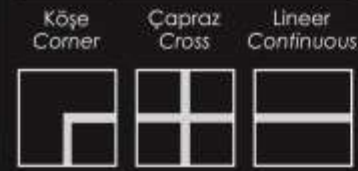

### Teknik Bilgiler / Technical Data

<b>Çalışma Gerilimi</b> Operating Voltage	85-260 V
<b>Güç / m</b> Power / m	10 W   20 W   32 W   64 W
<b>Işık Akısı / lm</b> Luminous flux	1000 lm   2000 lm   4000 lm   7500 lm
<b>Koruma</b> IP Grade	IP20/IP68   IP20/IP68   IP20   IP20
<b>Işık Rengi</b> Lighting Color	 2700 K   3000 K   4000 K   5000 K   6500 K   RGB
<b>Yüzey Dokusu</b> Surface appearance	Mat, Parlak, Satine Matt, Polished, Satine
<b>Renk Seçenekleri</b> Color Options	Tüm Alüminyum Eloksal Renkleri / All colors of electro-anodizing Tüm Elektrostatik Toz Boya Renkleri / All colors of electrostatic powder coating Tüm Ahşap Desenleri / All types of wood patterns
<b>Kontrol Seçenekleri</b> Controler Options	DALI, DIM (0-10 V, PWM, Resistor, Triac, Touch)
<b>Çalışma Sıcaklığı</b> Working Temperature	-25°C - +45°C

## Ln85 serisi / series

Ln85100

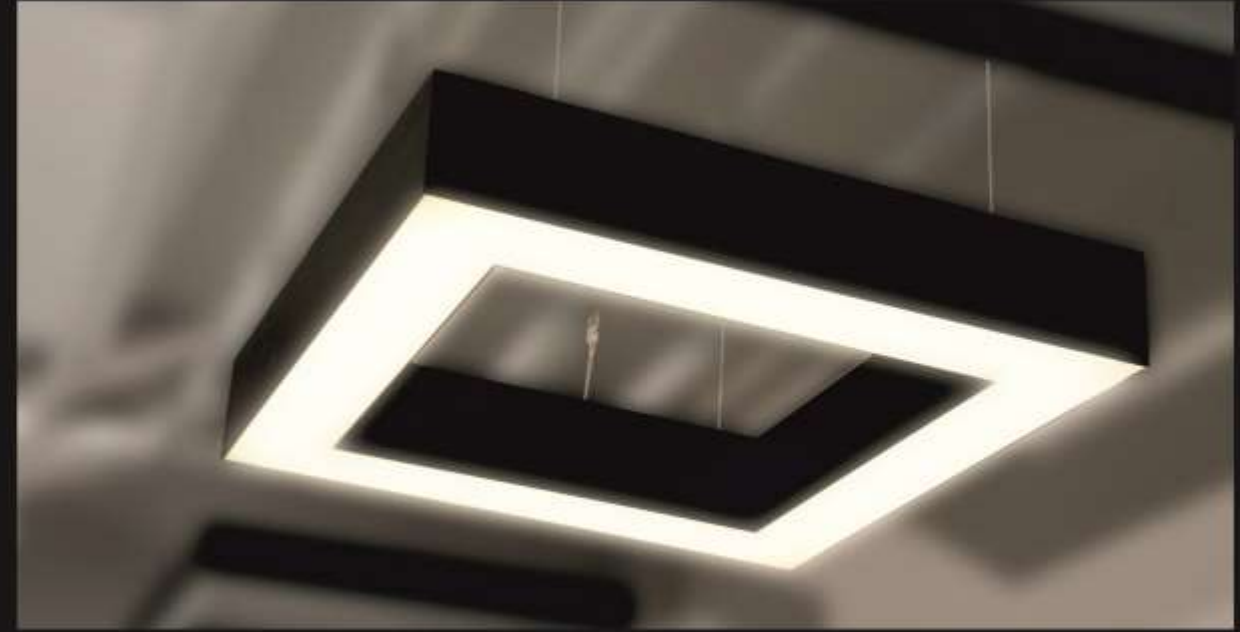

### Boyutlar / Dimensions

Uzunluk / Length:  
600mm, 1200mm, 3000mm

\*Özel ölçü üretilebilir. (max. 6000 mm)  
\*Custom production. (max. 6000 mm)

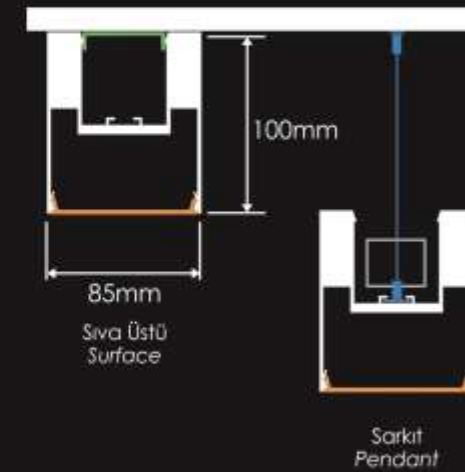



## lineerled / linearled



### Montaj / Mounting



### Bağlantı Opsiyonları Joiner Options

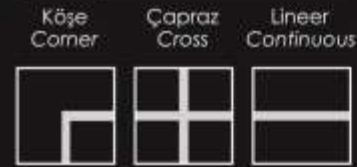

### Teknik Bilgiler / Technical Data

<b>Çalışma Gerilimi</b> Operating Voltage	85-260 V
<b>Güç / m</b> Power / m	10 W   20 W   32 W   64 W
<b>Işık Akısı / lm</b> Luminous flux	1000 lm   2000 lm   4000 lm   7500 lm
<b>Koruma</b> IP Grade	IP20/IP68   IP20/IP68   IP20   IP20
<b>Işık Rengi</b> Lighting Color	 2700 K   3000 K   4000 K   5000 K   6500 K   RGB
<b>Yüzey Dokusu</b> Surface appearance	Mat, Parlak, Satine Matt, Polished, Satine
<b>Renk Seçenekleri</b> Color Options	Tüm Alüminyum Eloksal Renkleri / All colors of electro-anodizing Tüm Elektrostatik Toz Boya Renkleri / All colors of electrostatic powder coating Tüm Ahşap Desenleri / All types of wood patterns
<b>Kontrol Seçenekleri</b> Controler Options	DALI, DIM (0-10 V, PWM, Resistor, Triac, Touch)
<b>Çalışma Sıcaklığı</b> Working Temperature	-25°C - +45°C

## Ln85 serisi / series

## Ln8580



### Boyutlar / Dimensions

Uzunluk / Length:  
600mm, 1200mm, 3000mm

\*Özel ölçü üretilebilir. (max. 6000 mm)  
\*Custom production.(max. 6000 mm)

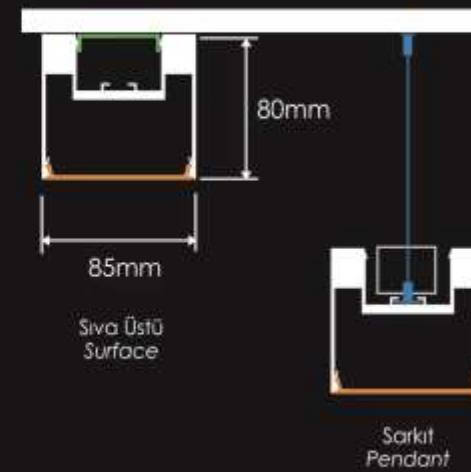

## lineerled / linearled



### Montaj / Mounting



### Bağlantı Opsiyonları Joiner Options

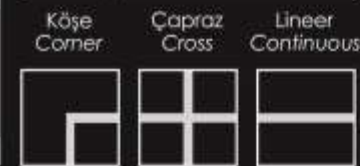

### Teknik Bilgiler / Technical Data

<b>Çalışma Gerilimi</b> Operating Voltage	85-260 V
<b>Güç / m</b> Power / m	10 W   20 W   32 W   64 W
<b>Işık Akısı / lm</b> Luminous flux	1000 lm   2000 lm   4000 lm   7500 lm
<b>Koruma</b> IP Grade	IP20/IP68   IP20/IP68   IP20   IP20
<b>Işık Rengi</b> Lighting Color	2700 K   3000 K   4000 K   5000 K   6500 K   RGB
<b>Yüzey Dokusu</b> Surface appearance	Mat, Parlak, Satine Matt, Polished, Satine
<b>Renk Seçenekleri</b> Color Options	Tüm Alüminyum Eloksal Renkleri / All colors of electro - anodizing Tüm Elektrostatik Toz Boya Renkleri / All colors of electrostatic powder coating Tüm Ahşap Desenleri / All types of wood patterns
<b>Kontrol Seçenekleri</b> Controler Options	DALI, DIM (0-10 V, PWM, Resistor, Triac, Touch)
<b>Çalışma Sıcaklığı</b> Working Temperature	-25°C - +45°C

## Ln85 serisi / series

Ln8560

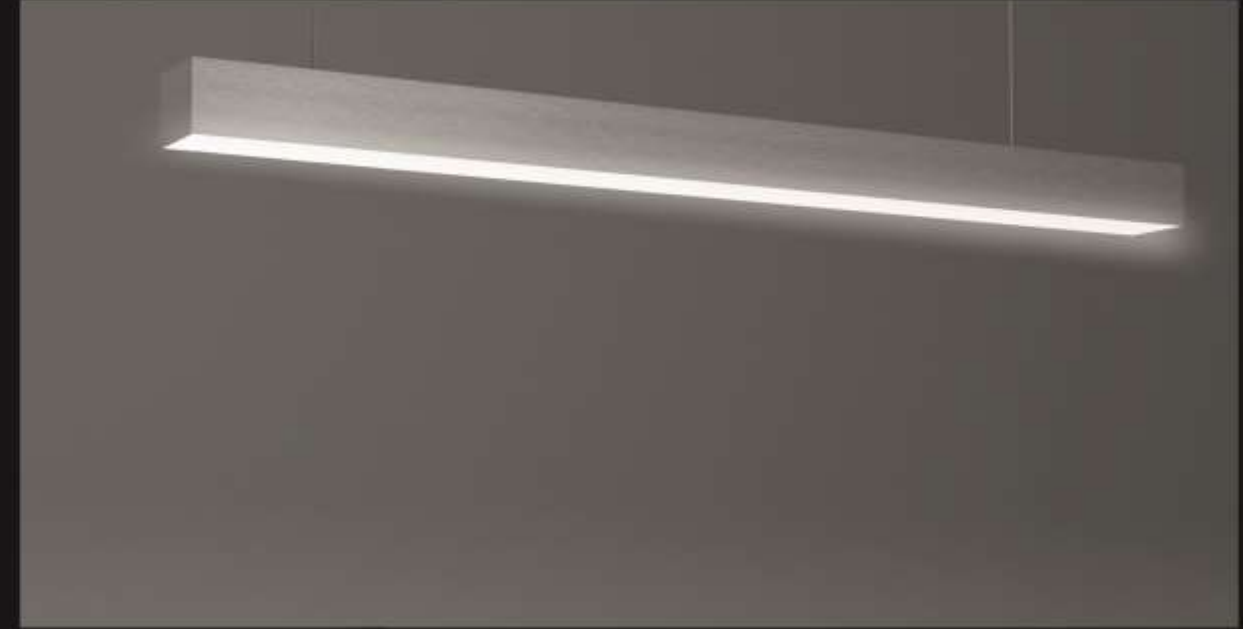

### Boyutlar / Dimensions

Uzunluk / Length:  
600mm, 1200mm, 3000mm

\*Özel ölçü üretilebilir. (max. 6000 mm)  
\*Custom production.(max. 6000 mm)

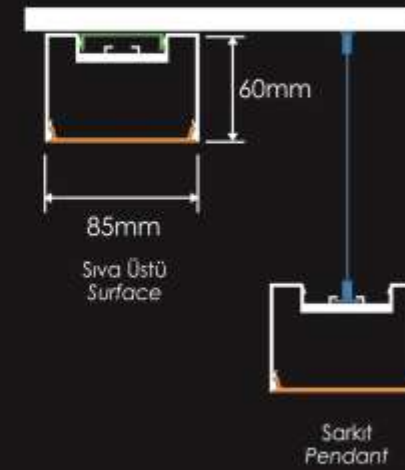

## lineerled / linearled



### Montaj / Mounting



### Bağlantı Opsiyonları Joiner Options

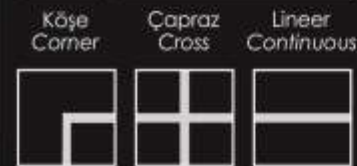

### Teknik Bilgiler / Technical Data

<b>Çalışma Gerilimi</b> Operating Voltage	85-260 V
<b>Güç / m</b> Power / m	20 W   40 W   64 W   128 W
<b>Işık Akısı / lm</b> Luminous flux	2000 lm   4000 lm   8000 lm   15000 lm
<b>Koruma</b> IP Grade	IP20/IP68   IP20/IP68   IP20   IP20
<b>Işık Rengi</b> Lighting Color	 2700 K   3000 K   4000 K   5000 K   6500 K   RGB
<b>Yüzey Dokusu</b> Surface appearance	Mat, Parlak, Satine Matt, polished, Satine
<b>Renk Seçenekleri</b> Color Options	Tüm Alüminyum Eloksal Renkleri / All colors of electro - anodizing Tüm Elektrostatik Toz Boya Renkleri / All colors of electrostatic powder coating Tüm Ahşap Desenleri / All types of wood patterns
<b>Kontrol Seçenekleri</b> Controler Options	DALI, DIM (0-10 V, PWM, Resistor, Triac, Touch)
<b>Çalışma Sıcaklığı</b> Working Temperature	-25°C - +45°C

## Ln12060



### Boyutlar / Dimensions

Uzunluk / Length:  
600mm, 1200mm, 3000mm

\*Özel ölçü üretilebilir. (max. 6000 mm)  
\*Custom production.(max. 6000 mm)

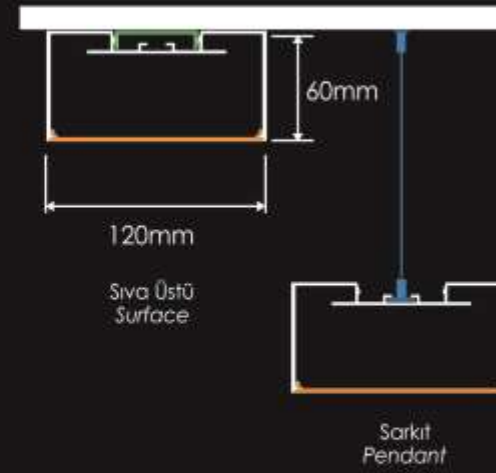



## lineerled / linearled

Lnt85

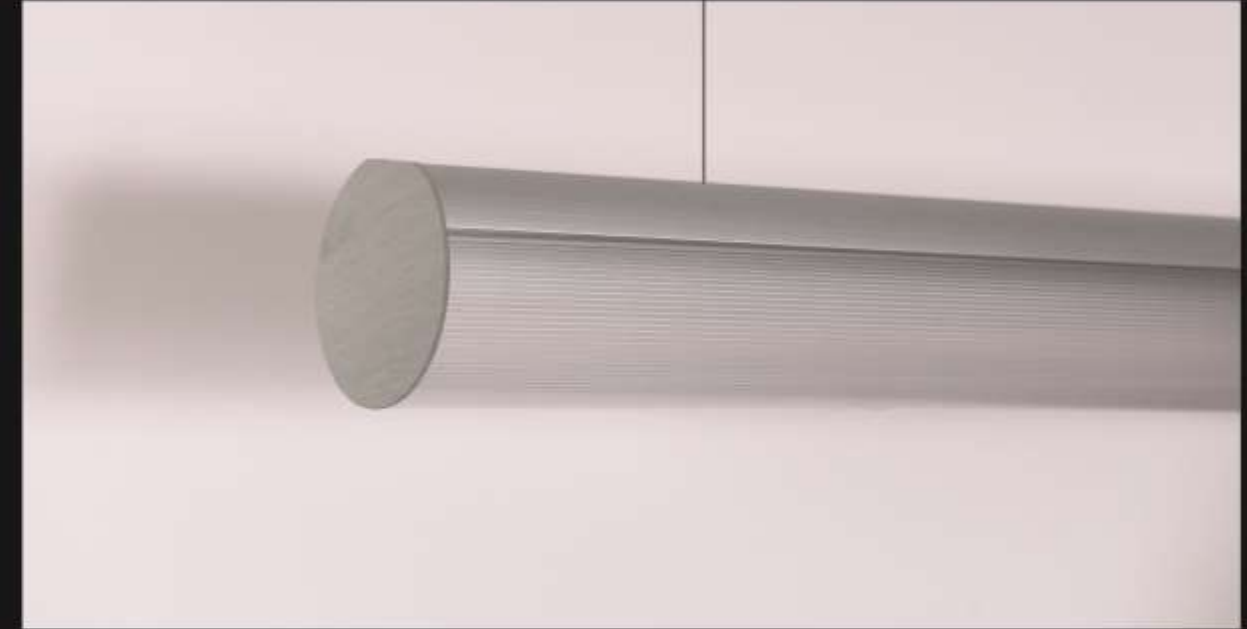
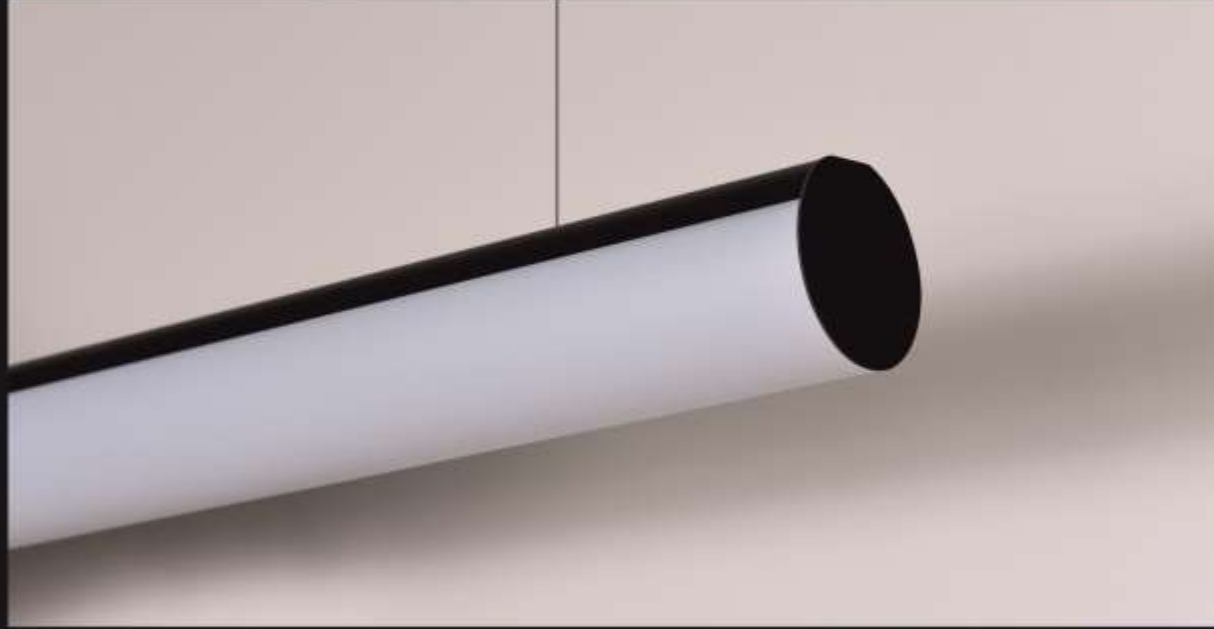

### Montaj / Mounting

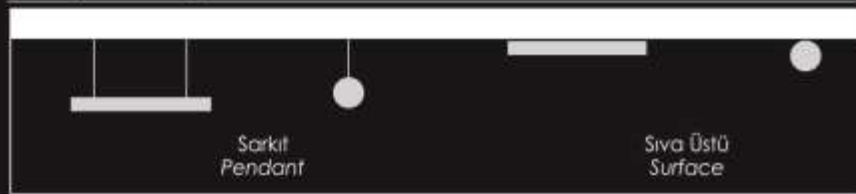

### Bağlantı Opsiyonları Joiner Options



### Teknik Bilgiler / Technical Data

<b>Çalışma Gerilimi</b> Operating Voltage	85-260 V	
<b>Güç / m</b> Power / m	36 W	72 W
<b>Işık Akısı / lm</b> Luminous flux	4000 lm	8000 lm
<b>Koruma</b> IP Grade	IP20/IP68	
<b>Işık Rengi</b> Lighting Color	 2700 K 3000 K 4000 K 5000 K 6500 K RGB	
<b>Yüzey Dokusu</b> Surface appearance	Akrilik / Acrylic	
<b>Renk Seçenekleri</b> Color Options	Beyaz /White	
<b>Kontrol Seçenekleri</b> Controler Options	DALI, DIM (0-10 V, PWM, Resistor, Triac, Touch)	
<b>Çalışma Sıcaklığı</b> Working Temperature	-25°C - +45°C	

### Boyutlar / Dimensions

Uzunluk / Length:  
600mm, 1200mm, 3000mm  
\*Özel ölçü üretilebilir. (max. 6000 mm)  
\*Custom production.(max. 6000 mm)

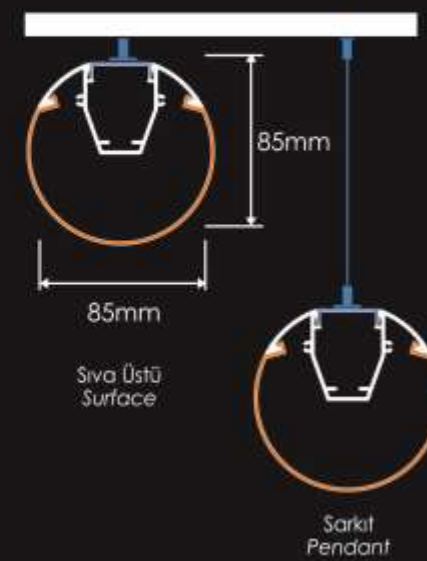

## lineerled / linearled

Lnt0



### Montaj / Mounting

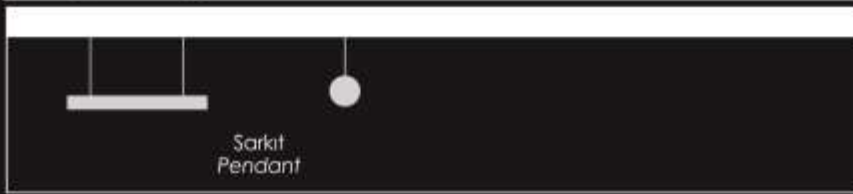

### Bağlantı Opsiyonları Joiner Options

Linear  
Continuous



### Teknik Bilgiler / Technical Data

<b>Çalışma Gerilimi</b> Operating Voltage	85-260 V
<b>Güç / m</b> Power / m	40 W
<b>Işık Akısı / lm</b> Luminous flux	4400 lm
<b>Koruma</b> IP Grade	IP20/IP68
<b>Işık Rengi</b> Lighting Color	
<b>Yüzey Dokusu</b> Surface appearance	Akrilik / Acrylic
<b>Renk Seçenekleri</b> Color Options	Beyaz /White
<b>Kontrol Seçenekleri</b> Controler Options	DALI, DIM (0-10 V, PWM, Resistor, Triac, Touch)
<b>Çalışma Sıcaklığı</b> Working Temperature	-25°C - +45°C

### Boyutlar / Dimensions

Uzunluk / Length:  
600mm, 1200mm, 3000mm

\*Özel ölçü üretilebilir. (max. 6000 mm)  
\*Custom production.(max. 6000 mm)

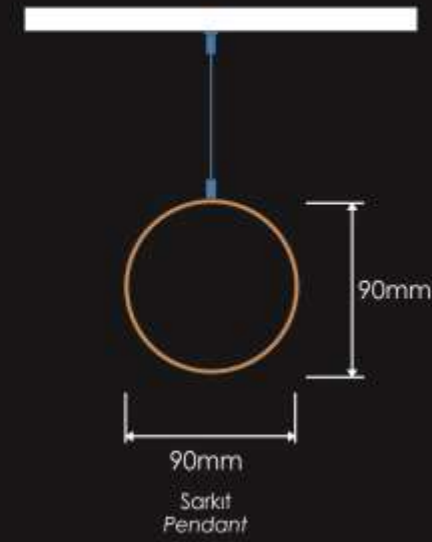

## linearled / linearled

Ln4080

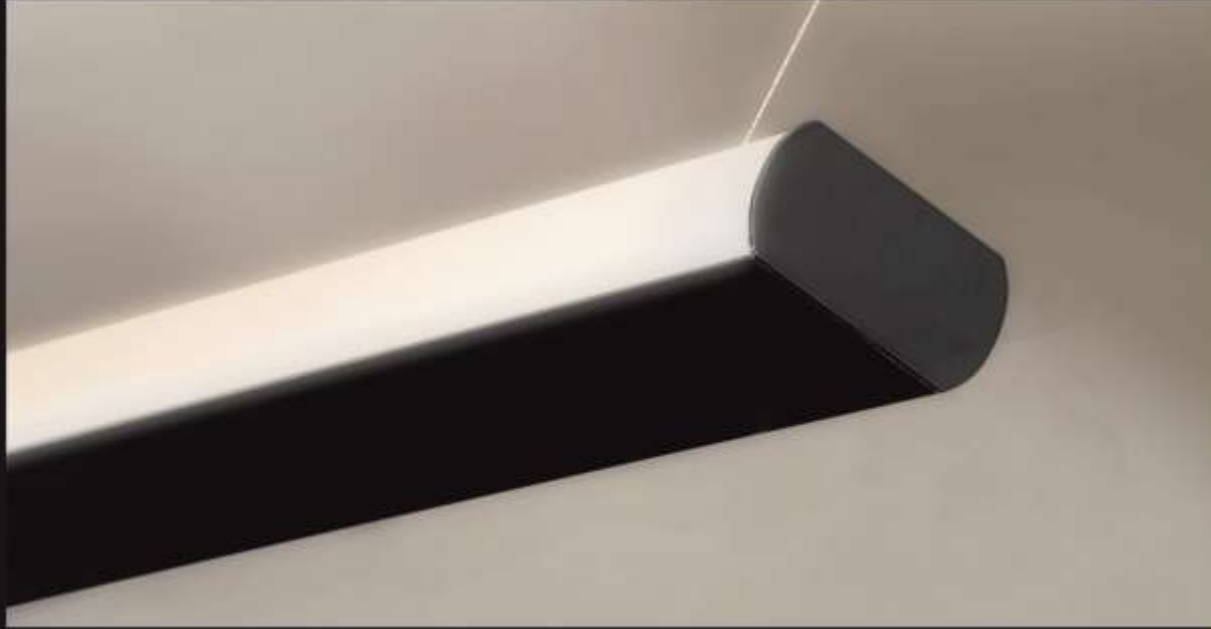

### Montaj / Mounting



### Bağlantı Opsiyonları Joiner Options



### Teknik Bilgiler / Technical Data

<b>Çalışma Gerilimi</b> Operating Voltage	85-260 V
<b>Güç / m</b> Power / m	20 W   64 W
<b>Işık Akısı / lm</b> Luminous flux	2000 lm   7500 lm
<b>Koruma</b> IP Grade	IP20/IP68   IP20
<b>Işık Rengi</b> Lighting Color	 2700 K   3000 K   4000 K   5000 K   6500 K   RGB
<b>Yüzey Dokusu</b> Surface appearance	Mat, Parlak, Satine Matt, Polished, Satine
<b>Renk Seçenekleri</b> Color Options	Tüm Alüminyum Eloksal Renkleri / All colors of electro - anodizing Tüm Elektrostatik Toz Boya Renkleri / All colors of electrostatic powder coating Tüm Ahşap Desenleri / All types of wood patterns
<b>Kontrol Seçenekleri</b> Controler Options	DALI, DIM (0-10 V, PWM, Resistor, Triac, Touch)
<b>Çalışma Sıcaklığı</b> Working Temperature	-25°C - +60°C

### Boyutlar / Dimensions

Uzunluk / Length:  
600mm, 1200mm, 3000mm

\*Özel ölçü üretilebilir. (max. 6000 mm)  
\*Custom production.(max. 6000 mm)

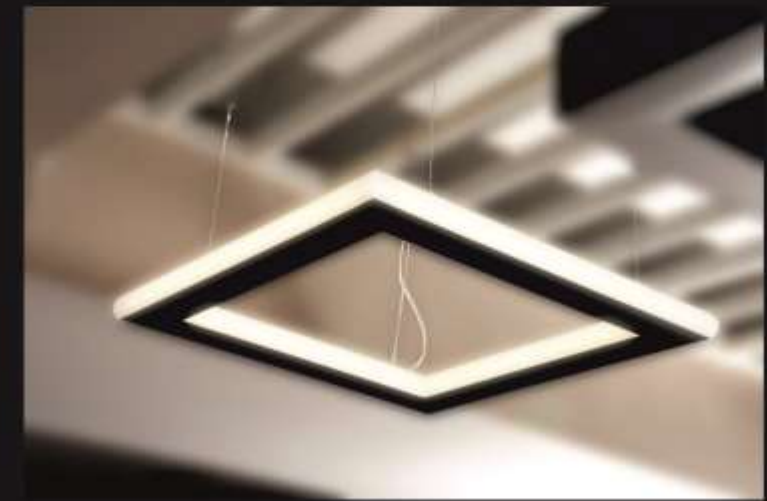
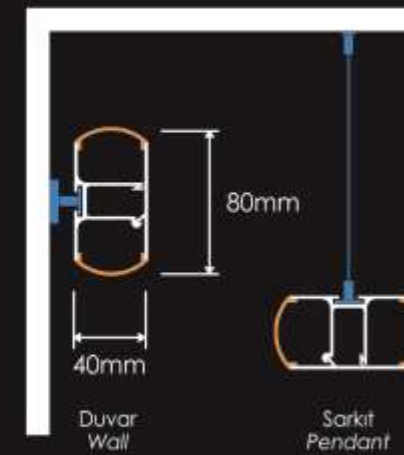
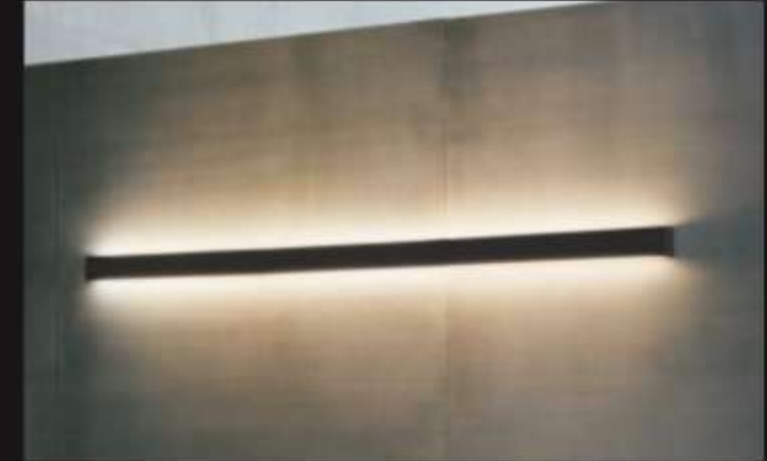



lineerled / lineerled

In4080

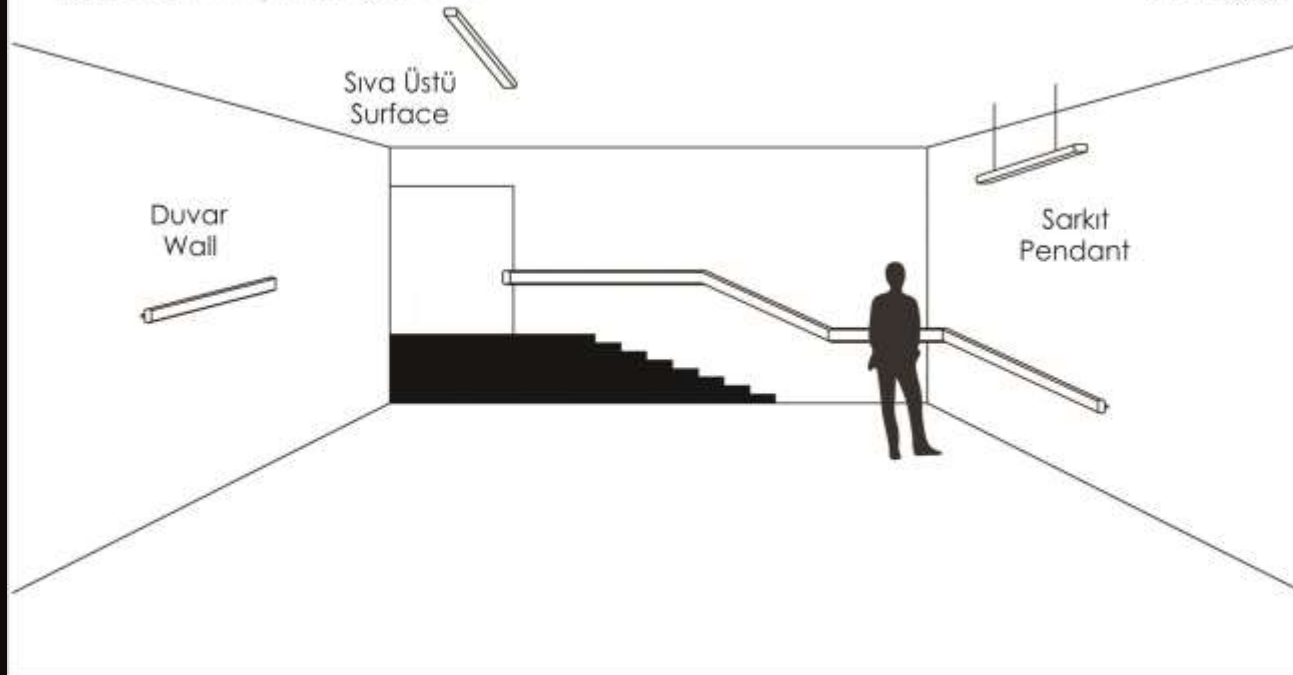

Led Küpeşte / Led Handrail

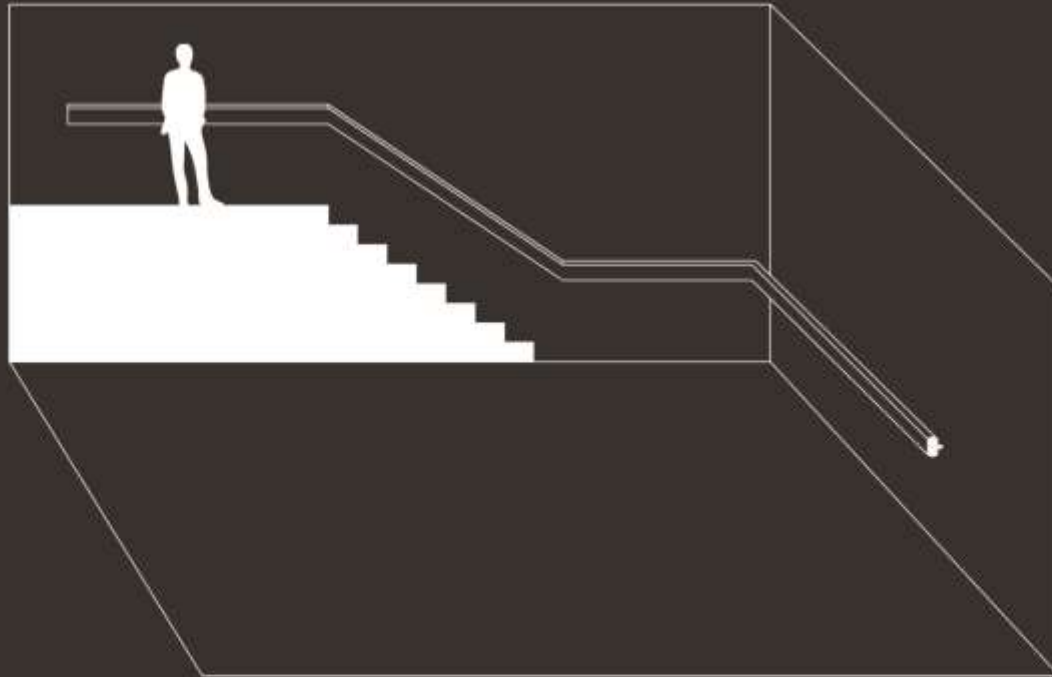

Köşe Aydınlatma  
Corner Lighting

## lineerled / linearled

Lnc11545



### Montaj / Mounting



### Bağlantı Opsiyonları Joiner Options

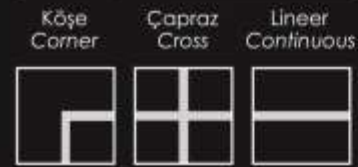

### Teknik Bilgiler / Technical Data

<b>Çalışma Gerilimi</b> Operating Voltage	85-260 V
<b>Güç / m</b> Power / m	20 W   40 W   64 W   128 W
<b>Işık Akısı / lm</b> Luminous flux	2000 lm   4000 lm   8000 lm   15000 lm
<b>Koruma</b> IP Grade	IP20/IP68   IP20/IP68   IP20   IP20
<b>Işık Rengi</b> Lighting Color	 2700 K   3000 K   4000 K   5000 K   6500 K   RGB
<b>Yüzey Dokusu</b> Surface appearance	Mat, Parlak, Satine Matt, Polished, Satine
<b>Renk Seçenekleri</b> Color Options	Tüm Alüminyum Eloksal Renkleri / All colors of electro-anodizing Tüm Elektrostatik Toz Boya Renkleri / All colors of electrostatic powder coating Tüm Ahşap Desenleri / All types of wood patterns
<b>Kontrol Seçenekleri</b> Controler Options	DALI, DIM (0-10 V, PWM, Resistor, Triac, Touch)
<b>Çalışma Sıcaklığı</b> Working Temperature	-25°C - +45°C

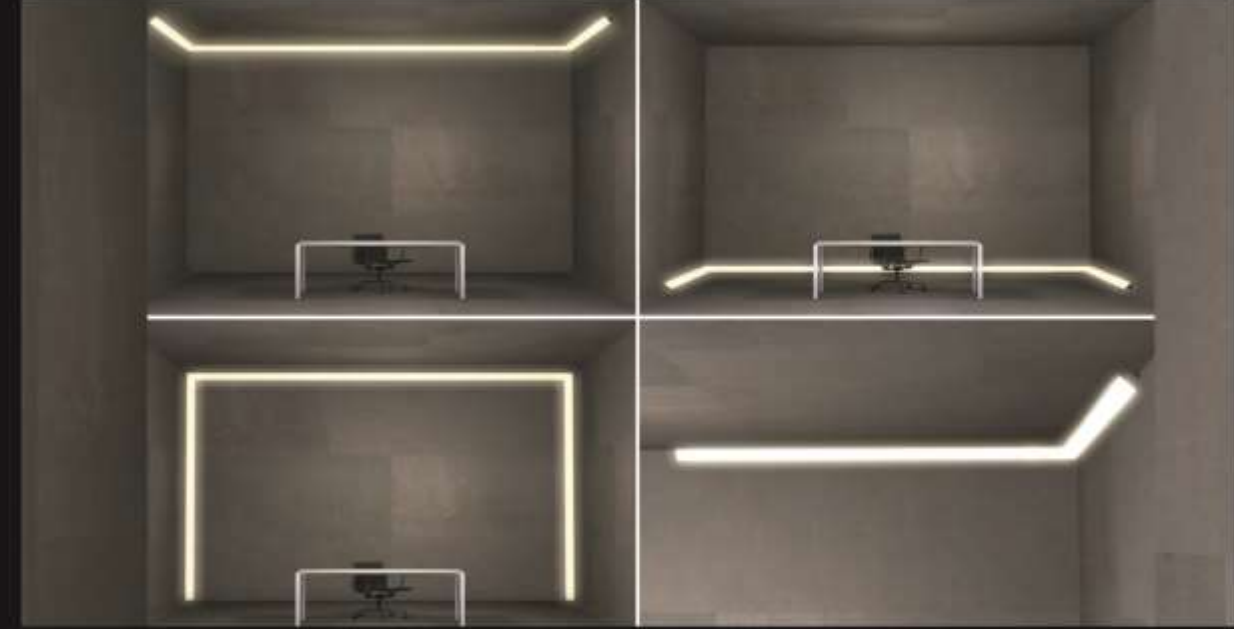

### Boyutlar / Dimensions

Uzunluk / Length:  
600mm, 1200mm, 3000mm

\*Özel ölçü üretilebilir. (max. 6000 mm)  
\*Custom production. (max. 6000 mm)

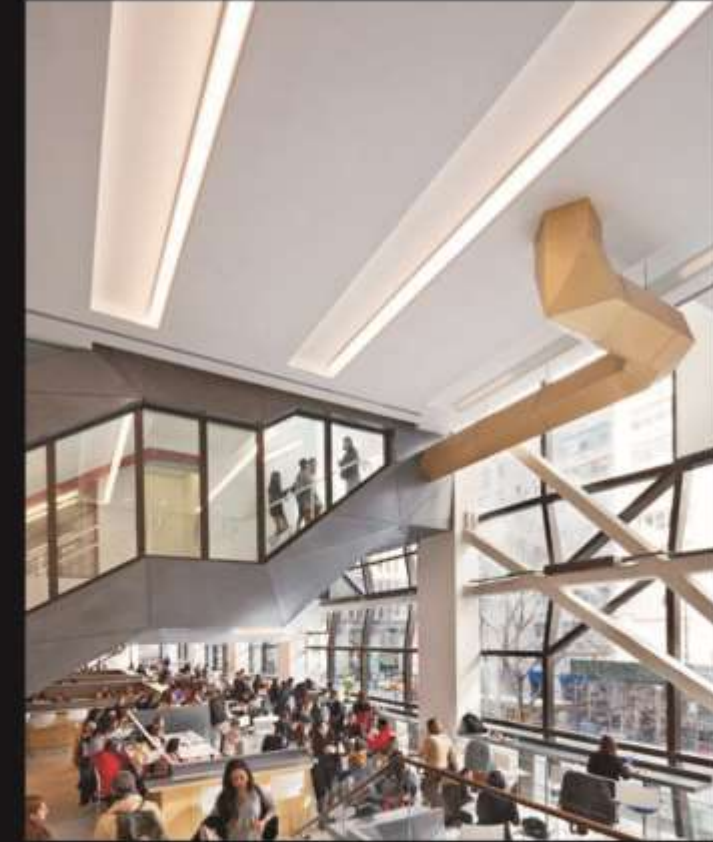
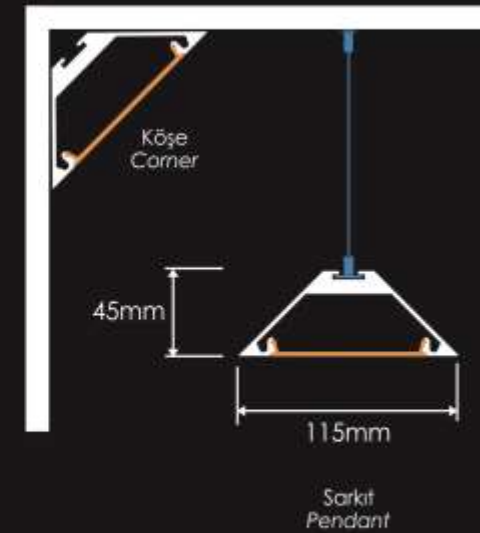



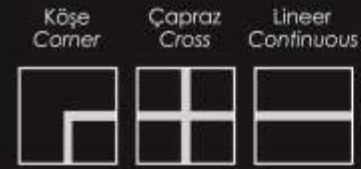

## Montaj / Mounting

Bağlantı Opsiyonları  
Joiner Options

## Boyutlar / Dimensions

Uzunluk / Length:  
600mm, 1200mm, 3000mm

\*Özel ölçü üretilebilir. (max. 6000 mm)  
\*Custom production. (max. 6000 mm)

## Teknik Bilgiler / Technical Data

<b>Çalışma Gerilimi</b> Operating Voltage	85-260 V
<b>Güç / m</b> Power / m	20 W   40 W   64 W   128 W
<b>Işık Akısı / lm</b> Luminous flux	2000 lm   4000 lm   8000 lm   15000 lm
<b>Koruma</b> IP Grade	IP20/IP68   IP20/IP68   IP20   IP20
<b>Işık Rengi</b> Lighting Color	 2700 K   3000 K   4000 K   5000 K   6500 K   RGB
<b>Yüzey Dokusu</b> Surface appearance	Mat, Parlak, Satine Matt, Polished, Satine
<b>Renk Seçenekleri</b> Color Options	Tüm Alüminyum Eloksal Renkleri / All colors of electro - anodizing Tüm Elektrostatik Toz Boya Renkleri / All colors of electrostatic powder coating Tüm Ahşap Desenleri / All types of wood patterns
<b>Kontrol Seçenekleri</b> Controler Options	DALI, DIM (0-10 V, PWM, Resistor, Triac, Touch)
<b>Çalışma Sıcaklığı</b> Working Temperature	-25°C - +45°C

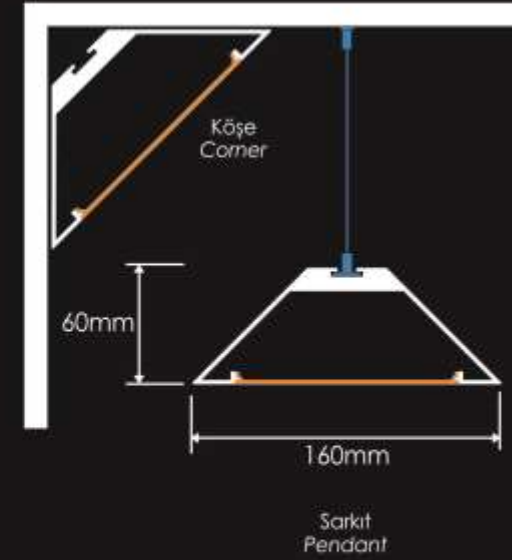



## LineerEtanj / LinearTri-proof



Ltj

## LineerYüksekTavan / LinearHighBay



Lyt

Montaj / Mounting

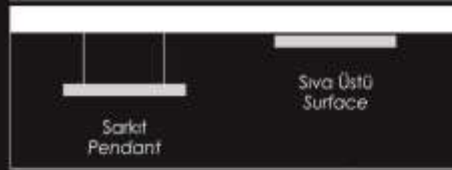

Boyutlar / Size



Teknik Bilgiler / Technical Data	600 mm	1200 mm	1500 mm
<b>Güç / m</b> Power / m	20 W	36 W	50 W
<b>Işık Akısı / lm</b> Luminous flux	2100 lm	3800 lm	5300 lm
<b>Işık Rengi</b> Lighting Color			
<b>Voltaaj</b> Voltage	AC 100V - 277V		
<b>Işık Açısı</b> Light Angle	120°		
<b>Koruma</b> IP Grade	IP65		
<b>Renk Seçenekleri</b> Color Options	Beyaz / White		
<b>Materyal</b> Material	Alüminyum + LGP / Aluminium + LGP		
<b>Kontrol Seçenekleri</b> Controler Options	DALI, DIM		
<b>Led</b>	5630		

Montaj / Mounting



Boyutlar / Size

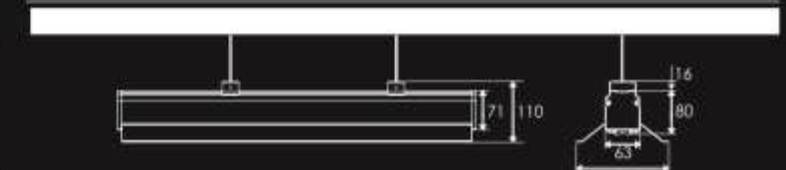

Teknik Bilgiler / Technical Data	600 mm	1200 mm	1500 mm
<b>Güç / m</b> Power / m	20 W	40 W	50 W
<b>Işık Akısı / lm</b> Luminous flux	2400 lm	4800 lm	6000 lm
<b>Işık Rengi</b> Lighting Color			
<b>Voltaaj</b> Voltage	AC 100V - 277V		
<b>Işık Açısı</b> Light Angle	60° / 90°		
<b>Koruma</b> IP Grade	IP44		
<b>Renk Seçenekleri</b> Color Options	Beyaz / White		
<b>Materyal</b> Material	Alüminyum + LGP / Aluminium + LGP		
<b>Kontrol Seçenekleri</b> Controler Options	DALI, DIM		
<b>Led</b>	5630		

**Lnk4080** Lambader

**linearled** siva altı / concealed

**Aralıksız Aydınlık**

Mimaride kesintisiz ışık çizgileri

*Continuous Light*

*Continuous light lines in architecture*



## lineerledinsert / linearledinsert

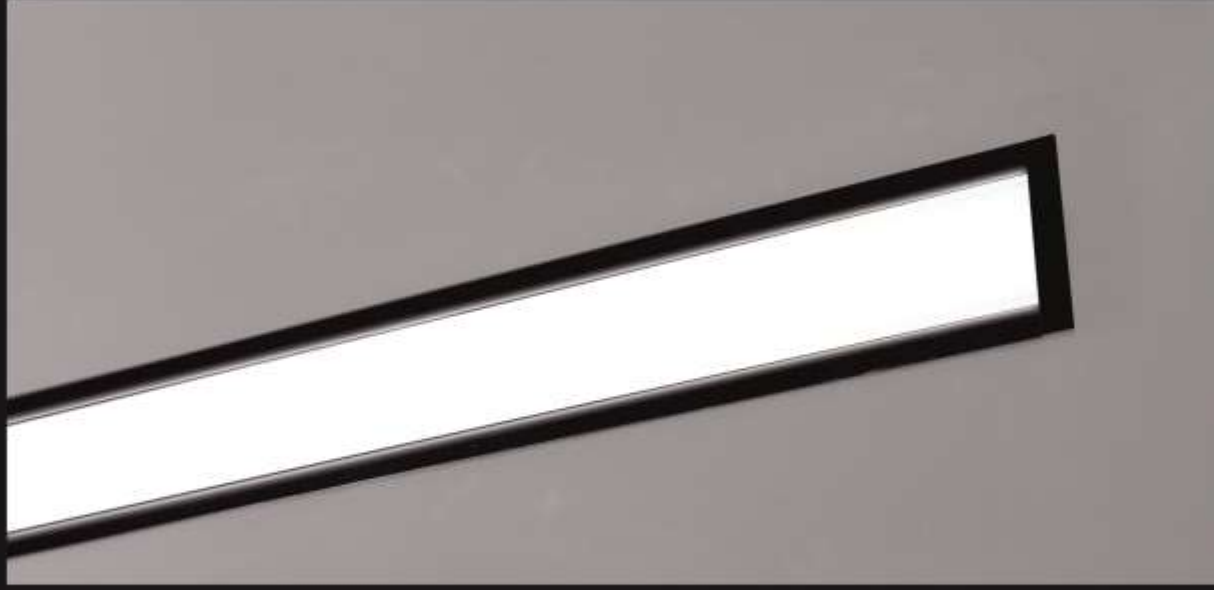

### Montaj / Montage

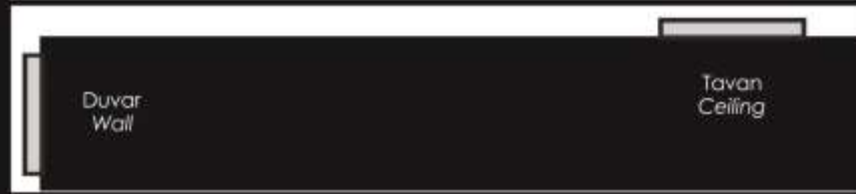

### Bağlantı Opsiyonları Joiner Options

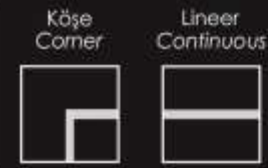

### Teknik Bilgiler / Technical Data

<b>Çalışma Gerilimi</b> Operating Voltage	85-260 V
<b>Güç / m</b> Power / m	10 W   20 W   32 W   64 W
<b>Işık Akısı / lm</b> Luminous flux	1000 lm   2000 lm   4000 lm   7500 lm
<b>Koruma</b> IP Grade	IP20/IP68   IP20/IP68   IP20   IP20
<b>Işık Rengi</b> Lighting Color	 2700 K   3000 K   4000 K   5000 K   6500 K   RGB
<b>Yüzey Dokusu</b> Surface appearance	Mat, Parlak, Satine Matt, Polished, Satine
<b>Renk Seçenekleri</b> Color Options	Tüm Alüminyum Eloksal Renkleri / All colors of electro-anodizing Tüm Elektrostatik Toz Boya Renkleri / All colors of electrostatic powder coating Tüm Ahşap Desenleri / All types of wood patterns
<b>Kontrol Seçenekleri</b> Controler Options	DALI, DIM (0-10 V, PWM, Resistor, Triac, Touch)
<b>Çalışma Sıcaklığı</b> Working Temperature	-25°C - +45°C

## Insert serisi / series

Lni5055



### Boyutlar / Dimensions

Uzunluk / Length:  
600mm, 1200mm, 3000mm

\*Özel ölçü üretilebilir. (max. 6000 mm)  
\*Custom production. (max. 6000 mm)

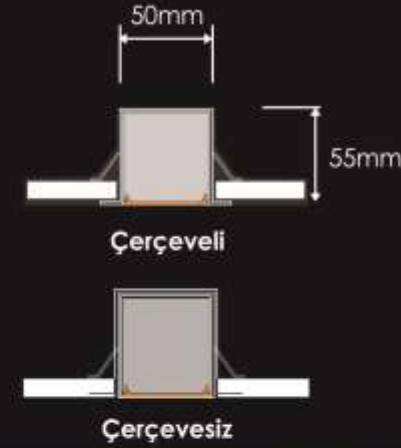



## lineerledinsert / linearledinsert

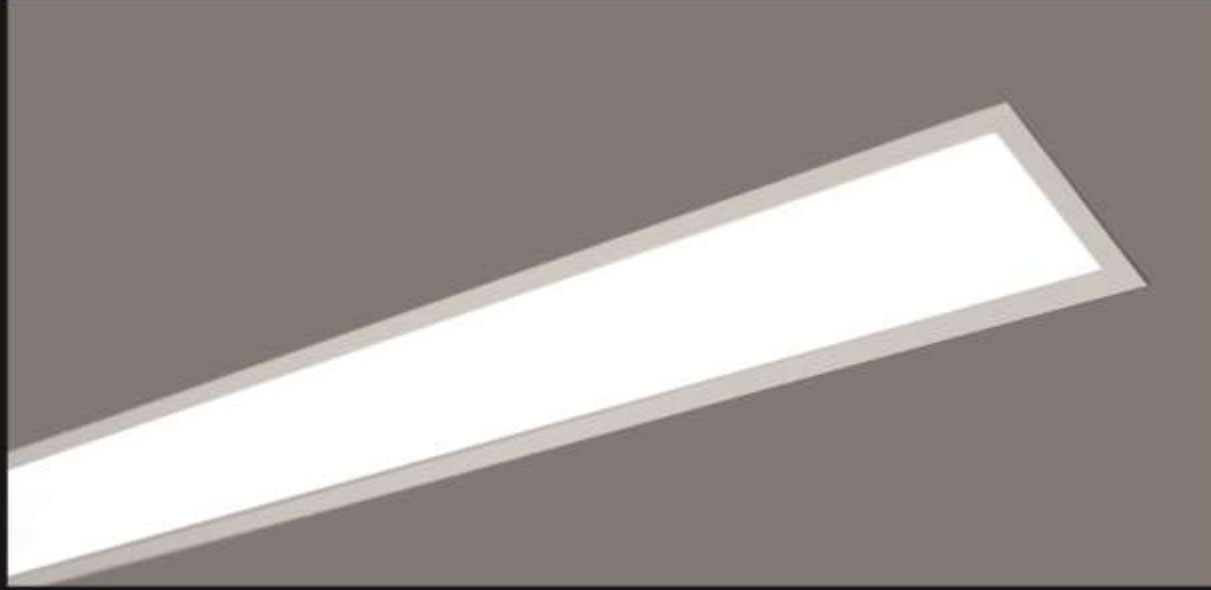

Montaj / Montage

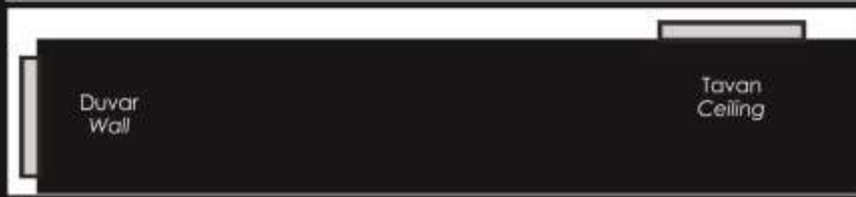

Bağlantı Opsiyonları  
Joiner Options

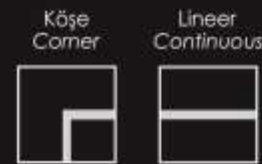

Teknik Bilgiler / Technical Data

<b>Çalışma Gerilimi</b> Operating Voltage	85-260 V
<b>Güç / m</b> Power / m	10 W   20 W   32 W   64 W
<b>Işık Akısı / lm</b> Luminous flux	1000 lm   2000 lm   4000 lm   7500 lm
<b>Koruma</b> IP Grade	IP20/IP68   IP20/IP68   IP20   IP20
<b>Işık Rengi</b> Lighting Color	 2700 K   3000 K   4000 K   5000 K   6500 K   RGB
<b>Yüzey Dokusu</b> Surface appearance	Mat, Parlak, Satine Matt, Polished, Satine
<b>Renk Seçenekleri</b> Color Options	Tüm Alüminyum Eloksal Renkleri / All colors of electro-anodizing Tüm Elektstatik Toz Boya Renkleri / All colors of electrostatic powder coating Tüm Ahşap Desenleri / All types of wood patterns
<b>Kontrol Seçenekleri</b> Controler Options	DALI, DIM (0-10 V, PWM, Resistor, Triac, Touch)
<b>Çalışma Sıcaklığı</b> Working Temperature	-25°C - +45°C

## Insert serisi / series

Lni7555



Boyutlar / Dimensions

Uzunluk / Length:  
600mm, 1200mm, 3000mm

\*Özel ölçü üretilebilir. (max. 6000 mm)  
\*Custom production. (max. 6000 mm)

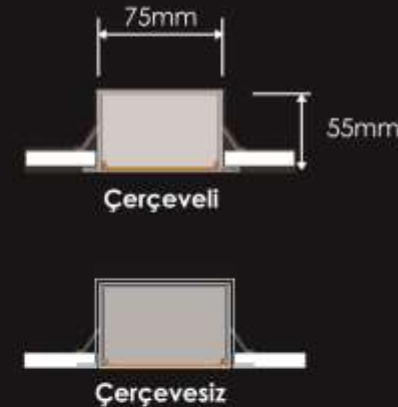

## lineerledinsert / linearledinsert

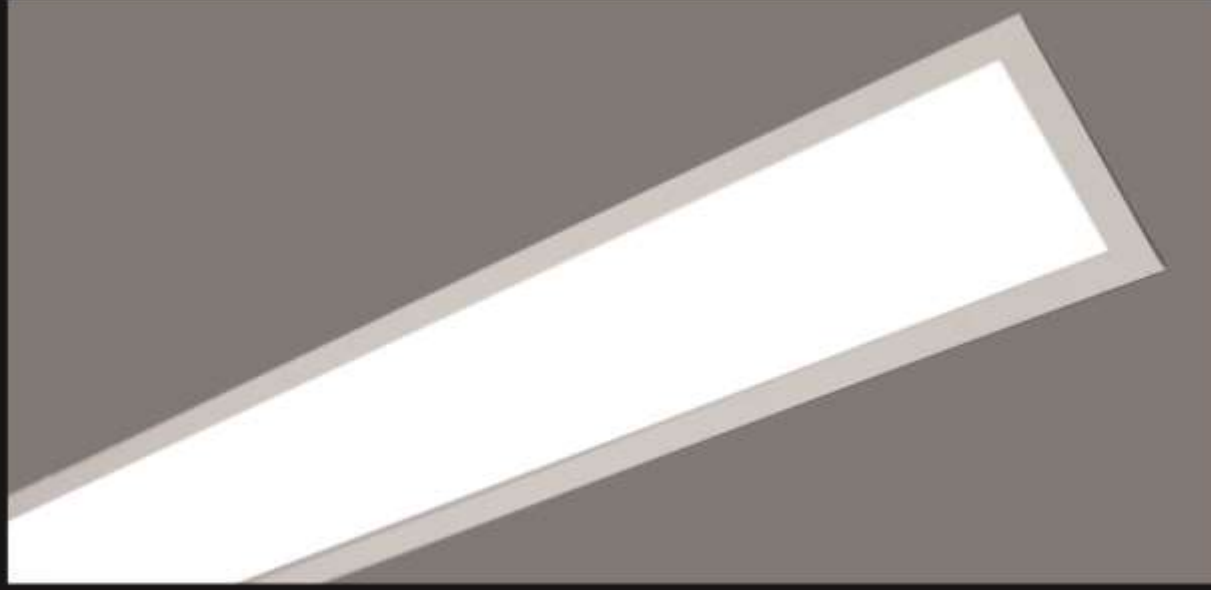

### Montaj / Montage



### Bağlantı Opsiyonları Joiner Options

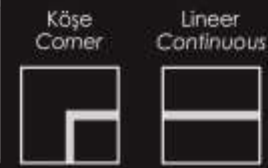

### Teknik Bilgiler / Technical Data

<b>Çalışma Gerilimi</b> Operating Voltage	85-260 V
<b>Güç / m</b> Power / m	20 W   40 W   64 W   128 W
<b>Işık Akısı / lm</b> Luminous flux	2000 lm   4000 lm   8000 lm   15000 lm
<b>Koruma</b> IP Grade	IP20/IP68   IP20/IP68   IP20   IP20
<b>Işık Rengi</b> Lighting Color	 2700 K   3000 K   4000 K   5000 K   6500 K   RGB
<b>Yüzey Dokusu</b> Surface appearance	Mat, Parlak, Satine Matt, Polished, Satine
<b>Renk Seçenekleri</b> Color Options	Tüm Alüminyum Eloksal Renkleri / All colors of electro - anodizing Tüm Elektrostatik Toz Boya Renkleri / All colors of electrostatic powder coating Tüm Ahşap Desenleri / All types of wood patterns
<b>Kontrol Seçenekleri</b> Controler Options	DALI, DIM (0-10 V, PWM, Resistor, Triac, Touch)
<b>Çalışma Sıcaklığı</b> Working Temperature	-25°C - +45°C

## Insert serisi / series

Lni12055

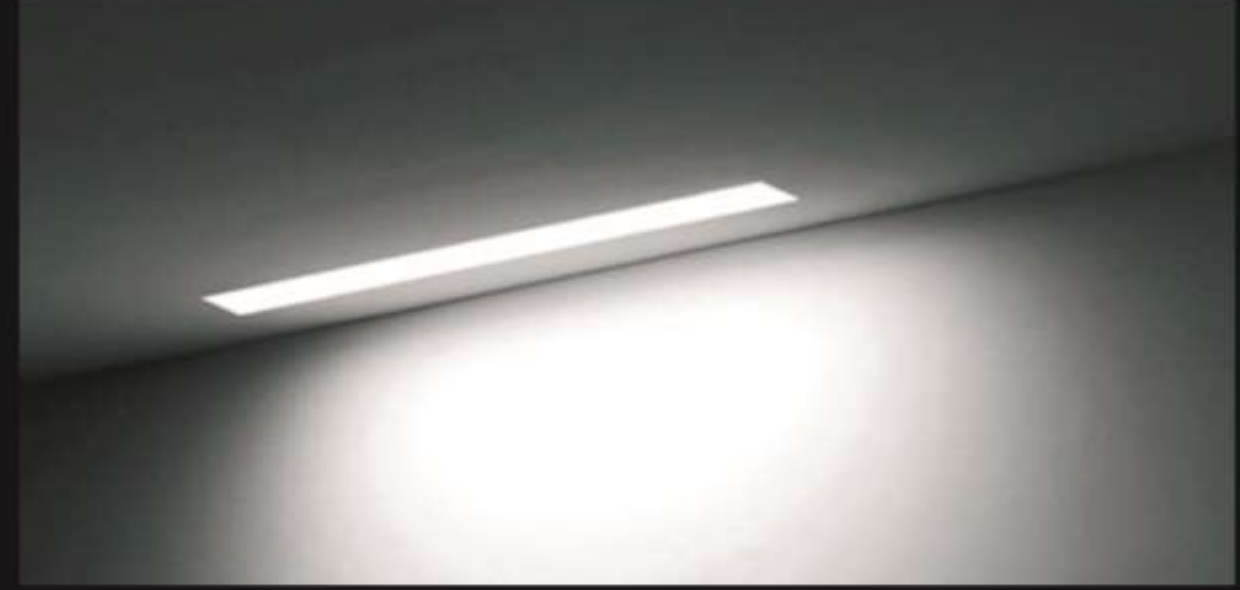

### Boyutlar / Dimensions

Uzunluk / Length:  
600mm, 1200mm, 3000mm

\*Özel ölçü üretilebilir. (max. 6000 mm)  
\*Custom production.(max. 6000 mm)

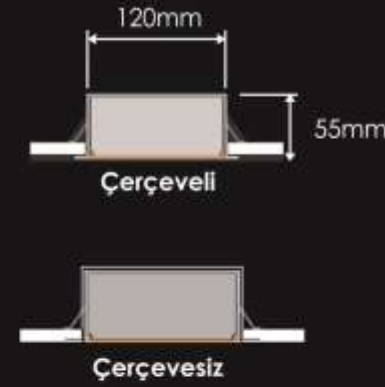



Led Panel





## LedPanel

Pn1481



### Montaj / Mounting



### Boyutlar / Size

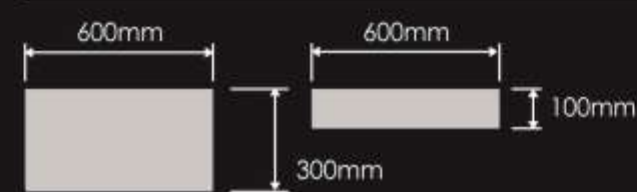

\*Özel ölçü üretilebilir.  
\*Custom production.

### Teknik Bilgiler / Technical Data

<b>Çalışma Gerilimi</b> Operating Voltage	100 - 240 V
<b>Güç / m</b> Power / m	36 W
<b>Işık Akısı / lm</b> Luminous flux	4500 lm
<b>Koruma</b> IP Grade	IP20/IP68
<b>Işık Rengi</b> Lighting Color	 2700 K 3000 K 4000 K 5000 K 6500 K RGB
<b>Renk Seçenekleri</b> Color Options	Tüm Elektrostatik Toz Boya Renkleri / All colors of electrostatic powder coating
<b>Kontrol Seçenekleri</b> Controler Options	DALI, DIM (0-10 V, PWM, Resistor, Triac, Touch)
<b>Çalışma Sıcaklığı</b> Working Temperature	-25°C - +45°C

## LedPanel

Pn1601



### Montaj / Mounting



### Boyutlar / Size

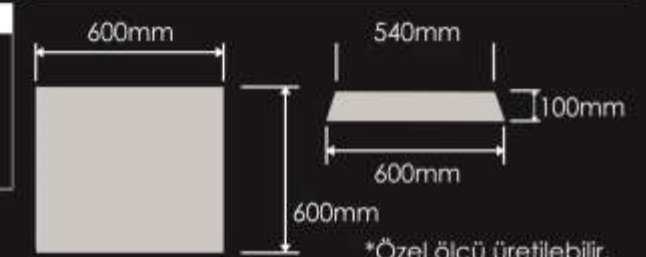

\*Özel ölçü üretilebilir.  
\*Custom production.

### Teknik Bilgiler / Technical Data

<b>Çalışma Gerilimi</b> Operating Voltage	100 - 240 V
<b>Güç / m</b> Power / m	36 W
<b>Işık Akısı / lm</b> Luminous flux	4500 lm
<b>Koruma</b> IP Grade	IP20/IP68
<b>Işık Rengi</b> Lighting Color	 2700 K 3000 K 4000 K 5000 K 6500 K RGB
<b>Renk Seçenekleri</b> Color Options	Tüm Elektrostatik Toz Boya Renkleri / All colors of electrostatic powder coating
<b>Kontrol Seçenekleri</b> Controler Options	DALI, DIM (0-10 V, PWM, Resistor, Triac, Touch)
<b>Çalışma Sıcaklığı</b> Working Temperature	-25°C - +45°C

## LedPanel

Pn1602



### Montaj / Mounting



### Boyutlar / Size

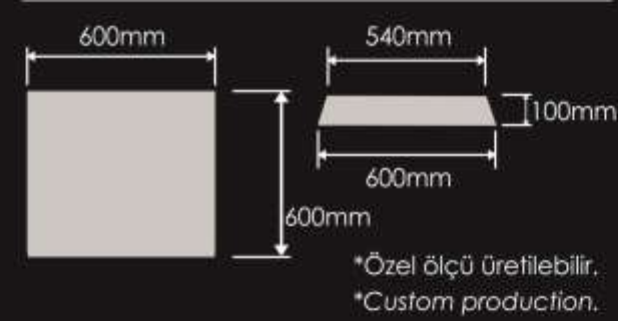

### Teknik Bilgiler / Technical Data

<b>Çalışma Gerilimi</b> Operating Voltage	100 - 240 V
<b>Güç / m</b> Power / m	36 W
<b>Işık Akısı / lm</b> Luminous flux	4500 lm
<b>Koruma</b> IP Grade	IP20/IP68
<b>Işık Rengi</b> Lighting Color	 2700 K 3000 K 4000 K 5000 K 6500 K RGB
<b>Renk Seçenekleri</b> Color Options	Tüm Elektrostatik Toz Boya Renkleri / All colors of electrostatic powder coating
<b>Kontrol Seçenekleri</b> Controler Options	DALI, DIM (0-10 V, PWM, Resistor, Triac, Touch)
<b>Çalışma Sıcaklığı</b> Working Temperature	-25°C - +45°C

## LedPanel

Pn1603



### Montaj / Mounting



### Boyutlar / Size

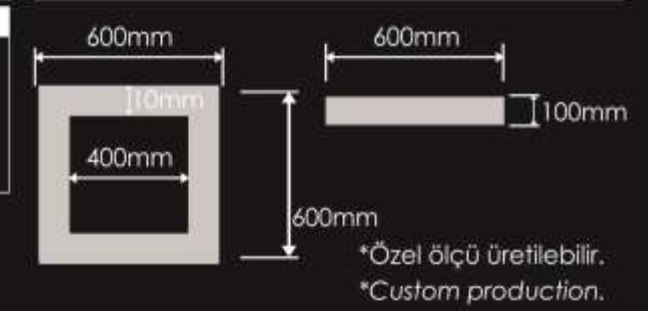

### Teknik Bilgiler / Technical Data

<b>Çalışma Gerilimi</b> Operating Voltage	100 - 240 V
<b>Güç / m</b> Power / m	36 W
<b>Işık Akısı / lm</b> Luminous flux	4500 lm
<b>Koruma</b> IP Grade	IP20/IP68
<b>Işık Rengi</b> Lighting Color	 2700 K 3000 K 4000 K 5000 K 6500 K RGB
<b>Renk Seçenekleri</b> Color Options	Tüm Elektrostatik Toz Boya Renkleri / All colors of electrostatic powder coating
<b>Kontrol Seçenekleri</b> Controler Options	DALI, DIM (0-10 V, PWM, Resistor, Triac, Touch)
<b>Çalışma Sıcaklığı</b> Working Temperature	-25°C - +45°C

## LedPanel

Pn2381



### Montaj / Mounting



### Boyutlar / Size

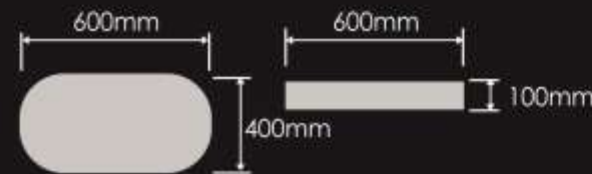

\*Özel ölçü üretilebilir.  
\*Custom production.

### Teknik Bilgiler / Technical Data

<b>Çalışma Gerilimi</b> Operating Voltage	100 - 240 V
<b>Güç / m</b> Power / m	36 W
<b>Işık Akısı / lm</b> Luminous flux	4500 lm
<b>Koruma</b> IP Grade	IP20/IP68
<b>Işık Rengi</b> Lighting Color	 2700 K 3000 K 4000 K 5000 K 6500 K RGB
<b>Renk Seçenekleri</b> Color Options	Tüm Elektrostatik Toz Boya Renkleri / All colors of electrostatic powder coating
<b>Kontrol Seçenekleri</b> Controler Options	DALI, DIM (0-10 V, PWM, Resistor, Triac, Touch)
<b>Çalışma Sıcaklığı</b> Working Temperature	-25°C - +45°C

## LedPanel

Pn2481



### Montaj / Mounting



### Boyutlar / Size

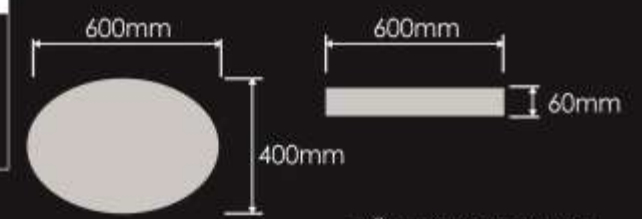

\*Özel ölçü üretilebilir.  
\*Custom production.

### Teknik Bilgiler / Technical Data

<b>Çalışma Gerilimi</b> Operating Voltage	100 - 240 V
<b>Güç / m</b> Power / m	36 W
<b>Işık Akısı / lm</b> Luminous flux	4500 lm
<b>Koruma</b> IP Grade	IP20/IP68
<b>Işık Rengi</b> Lighting Color	 2700 K 3000 K 4000 K 5000 K 6500 K RGB
<b>Renk Seçenekleri</b> Color Options	Tüm Elektrostatik Toz Boya Renkleri / All colors of electrostatic powder coating
<b>Kontrol Seçenekleri</b> Controler Options	DALI, DIM (0-10 V, PWM, Resistor, Triac, Touch)
<b>Çalışma Sıcaklığı</b> Working Temperature	-25°C - +45°C



## LedPanel

Pn2601



### Montaj / Mounting



### Boyutlar / Size

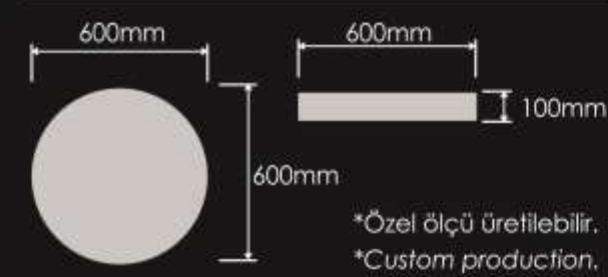

### Teknik Bilgiler / Technical Data

<b>Çalışma Gerilimi</b> Operating Voltage	100 - 240 V
<b>Güç / m</b> Power / m	36 W
<b>Işık Akısı / lm</b> Luminous flux	4500 lm
<b>Koruma</b> IP Grade	IP20/IP68
<b>Işık Rengi</b> Lighting Color	 2700 K 3000 K 4000 K 5000 K 6500 K RGB
<b>Renk Seçenekleri</b> Color Options	Tüm Elektrostatik Toz Boya Renkleri / All colors of electrostatic powder coating
<b>Kontrol Seçenekleri</b> Controler Options	DALI, DIM (0-10 V, PWM, Resistor, Triac, Touch)
<b>Çalışma Sıcaklığı</b> Working Temperature	-25°C - +45°C

## LedPanel

Pn2602



### Montaj / Mounting



### Boyutlar / Size

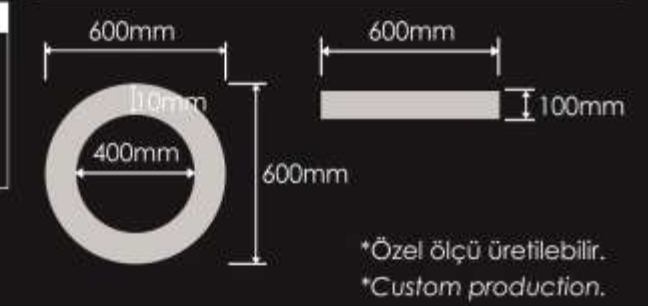

### Teknik Bilgiler / Technical Data

<b>Çalışma Gerilimi</b> Operating Voltage	100 - 240 V
<b>Güç / m</b> Power / m	36 W
<b>Işık Akısı / lm</b> Luminous flux	4500 lm
<b>Koruma</b> IP Grade	IP20/IP68
<b>Işık Rengi</b> Lighting Color	 2700 K 3000 K 4000 K 5000 K 6500 K RGB
<b>Renk Seçenekleri</b> Color Options	Tüm Elektrostatik Toz Boya Renkleri / All colors of electrostatic powder coating
<b>Kontrol Seçenekleri</b> Controler Options	DALI, DIM (0-10 V, PWM, Resistor, Triac, Touch)
<b>Çalışma Sıcaklığı</b> Working Temperature	-25°C - +45°C

## LedPanel / BackLight

Pnb



### Montaj / Mounting



### Boyutlar / Size



Teknik Bilgiler / Technical Data	Pnb6060	Pnb3030	Pnb30120			
<b>Güç / m</b> Power / m	28 W	7 W	28 W			
<b>Işık Akısı / lm</b> Luminous flux	2650 lm	650 lm	2650lm			
<b>Işık Rengi</b> Lighting Color	 2700 K	 3000 K	 4000 K	 5000 K	 6500 K	 RGB
<b>Çalışma Gerilimi</b> Operating Voltage	AC 85V - 265V					
<b>Işık Açısı</b> Light Angle	180°					
<b>Koruma</b> IP Grade	IP20					
<b>Renk Seçenekleri</b> Color Options	Beyaz / White					
<b>Materyal</b> Material	Alüminyum + LGP / Aluminium + LGP					
<b>Kontrol Seçenekleri</b> Controler Options	DIM (Triac)					
<b>Led</b>	2835					





## LedPanelSlim

Pns



Montaj / Mounting



Boyutlar / Size

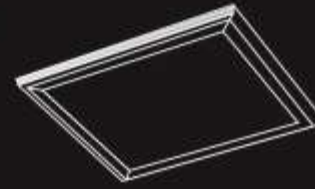

Pns6060  
598mm X 598mm X 9mm

Pns3030  
298mm X 298mm X 9mm

Pns30120  
298mm X 1198mm X 9mm

Teknik Bilgiler / Technical Data	Pns6060	Pns3030	Pns30120		
<b>Güç / m</b> Power / m	40 W	20 W	60 W		
<b>Işık Akısı / lm</b> Luminous flux	3200 lm	1600 lm	4800 lm		
<b>Işık Rengi</b> Lighting Color	 2700 K	 3000 K	 4000 K	 5000 K	 6500 K
<b>Çalışma Gerilimi</b> Operating Voltage	AC 85V - 265V				
<b>Işık Açısı</b> Light Angle	180°				
<b>Koruma</b> IP Grade	IP20				
<b>Renk Seçenekleri</b> Color Options	Beyaz / White				
<b>Materyal</b> Material	Alüminyum + LGP / Aluminium + LGP				
<b>Kontrol Seçenekleri</b> Controler Options	DIM (Triac)				
<b>Led</b>	3014				

## LedPanelSpot SlimDownlight





## LedPanelSpot / LedPanelDownlight

Psk12006



Montaj / Mounting



Boyutlar / Size

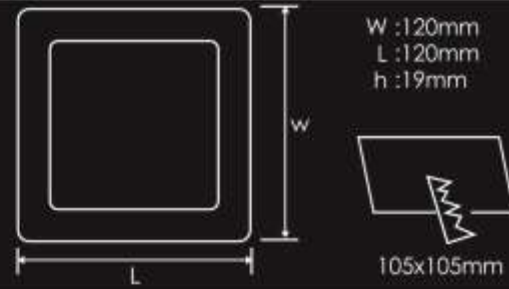

W :120mm  
L :120mm  
h :19mm

105x105mm

Teknik Bilgiler / Technical Data

<b>Güç / m</b> Power / m	6 W
<b>Işık Akısı / lm</b> Luminous flux	420 lm
<b>Işık Rengi</b> Lighting Color	 2700 K 3000 K 4000 K 5000 K 6500 K
<b>Çalışma Gerilimi</b> Operating Voltage	AC 85V - 265V
<b>Işık Açısı</b> Light Angle	180°
<b>Koruma</b> IP Grade	IP20
<b>Renk Seçenekleri</b> Color Options	Beyaz / White
<b>Materyal</b> Material	Alüminyum + LGP / Aluminium + LGP
<b>Kontrol Seçenekleri</b> Controler Options	DIM (Triac)
<b>Led</b>	2835

62

## LedPanelSpot / LedPanelDownlight

Psk17212



Montaj / Mounting



Boyutlar / Size

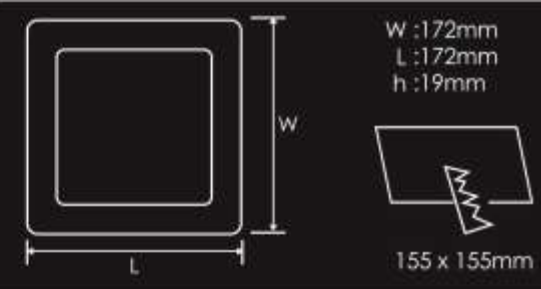

W :172mm  
L :172mm  
h :19mm

155 x 155mm

Teknik Bilgiler / Technical Data

<b>Güç / m</b> Power / m	12 W
<b>Işık Akısı / lm</b> Luminous flux	820 lm
<b>Işık Rengi</b> Lighting Color	 2700 K 3000 K 4000 K 5000 K 6500 K
<b>Çalışma Gerilimi</b> Operating Voltage	AC 85V - 265V
<b>Işık Açısı</b> Light Angle	38°
<b>Koruma</b> IP Grade	IP20
<b>Renk Seçenekleri</b> Color Options	Beyaz / White
<b>Materyal</b> Material	Alüminyum + LGP / Aluminium + LGP
<b>Kontrol Seçenekleri</b> Controler Options	DIM (Triac)
<b>Led</b>	2835

63

## LedPanelSpot / LedPanelDownlight

Psk22516



Montaj / Mounting



Boyutlar / Size

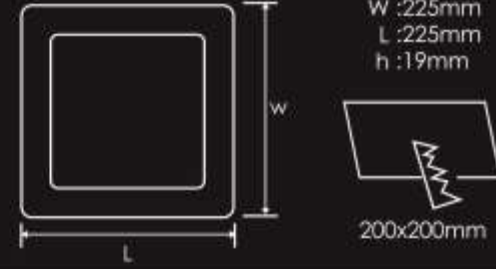

Teknik Bilgiler / Technical Data

<b>Güç / m</b> Power / m	16 W
<b>Işık Akısı / lm</b> Luminous flux	1580 lm
<b>Işık Rengi</b> Lighting Color	 2700 K 3000 K 4000 K 5000 K 6500 K
<b>Çalışma Gerilimi</b> Operating Voltage	AC 85V - 265V
<b>Işık Açısı</b> Light Angle	180°
<b>Koruma</b> IP Grade	IP20
<b>Renk Seçenekleri</b> Color Options	Beyaz / White
<b>Materyal</b> Material	Alüminyum + LGP / Aluminium + LGP
<b>Kontrol Seçenekleri</b> Controler Options	DIM ( Triac)
<b>Led</b>	2835

## LedPanelSpot / LedPanelDownlight

Psd12006



Montaj / Mounting



Boyutlar / Size



Teknik Bilgiler / Technical Data

<b>Güç / m</b> Power / m	6 W
<b>Işık Akısı / lm</b> Luminous flux	480 lm
<b>Işık Rengi</b> Lighting Color	 2700 K 3000 K 4000 K 5000 K 6500 K
<b>Çalışma Gerilimi</b> Operating Voltage	AC 85V - 265V
<b>Işık Açısı</b> Light Angle	180°
<b>Koruma</b> IP Grade	IP20
<b>Renk Seçenekleri</b> Color Options	Beyaz / White
<b>Materyal</b> Material	Alüminyum + LGP / Aluminium + LGP
<b>Kontrol Seçenekleri</b> Controler Options	DIM (Triac)
<b>Led</b>	3014



## LedPanelSpot / LedPanelDownlight

Psd14508



Montaj / Mounting



Boyutlar / Size



Teknik Bilgiler / Technical Data

<b>Güç / m</b> Power / m	8 W
<b>Işık Akısı / lm</b> Luminous flux	640 lm
<b>Işık Rengi</b> Lighting Color	 2700 K 3000 K 4000 K 5000 K 6500 K
<b>Çalışma Gerilimi</b> Operating Voltage	AC 85V - 265V
<b>Işık Açısı</b> Light Angle	180°
<b>Koruma</b> IP Grade	IP20
<b>Renk Seçenekleri</b> Color Options	Beyaz / White
<b>Materyal</b> Material	Alüminyum + LGP / Aluminium + LGP
<b>Kontrol Seçenekleri</b> Controler Options	DIM (Triac)
<b>Led</b>	3014

## LedPanelSpot

Psd20016



Montaj / Mounting



Boyutlar / Size



Teknik Bilgiler / Technical Data

<b>Güç / m</b> Power / m	16 W
<b>Işık Akısı / lm</b> Luminous flux	1280 lm
<b>Işık Rengi</b> Lighting Color	 2700 K 3000 K 4000 K 5000 K 6500 K
<b>Çalışma Gerilimi</b> Operating Voltage	AC 85V - 265V
<b>Işık Açısı</b> Light Angle	180°
<b>Koruma</b> IP Grade	IP20
<b>Renk Seçenekleri</b> Color Options	Beyaz / White
<b>Materyal</b> Material	Alüminyum + LGP / Aluminium + LGP
<b>Kontrol Seçenekleri</b> Controler Options	DIM (Triac)
<b>Led</b>	3014



## LedPanelSpot / LedPanelDownlight

Psd23020



Montaj / Mounting



Boyutlar / Size



h : 22mm  
Ø : 230mm

Ø : 210mm

Teknik Bilgiler / Technical Data

<b>Güç / m</b> Power / m	20 W
<b>Işık Akısı / lm</b> Luminous flux	1450 lm
<b>Işık Rengi</b> Lighting Color	 2700 K 3000 K 4000 K 5000 K 6500 K
<b>Çalışma Gerilimi</b> Operating Voltage	AC 85V - 265V
<b>Işık Açısı</b> Light Angle	180°
<b>Koruma</b> IP Grade	IP20
<b>Renk Seçenekleri</b> Color Options	Beyaz / White
<b>Materyal</b> Material	Alüminyum + LGP / Aluminium + LGP
<b>Kontrol Seçenekleri</b> Controler Options	DIM (Triac)
<b>Led</b>	3014

68

LedSpot  
LedDownlight

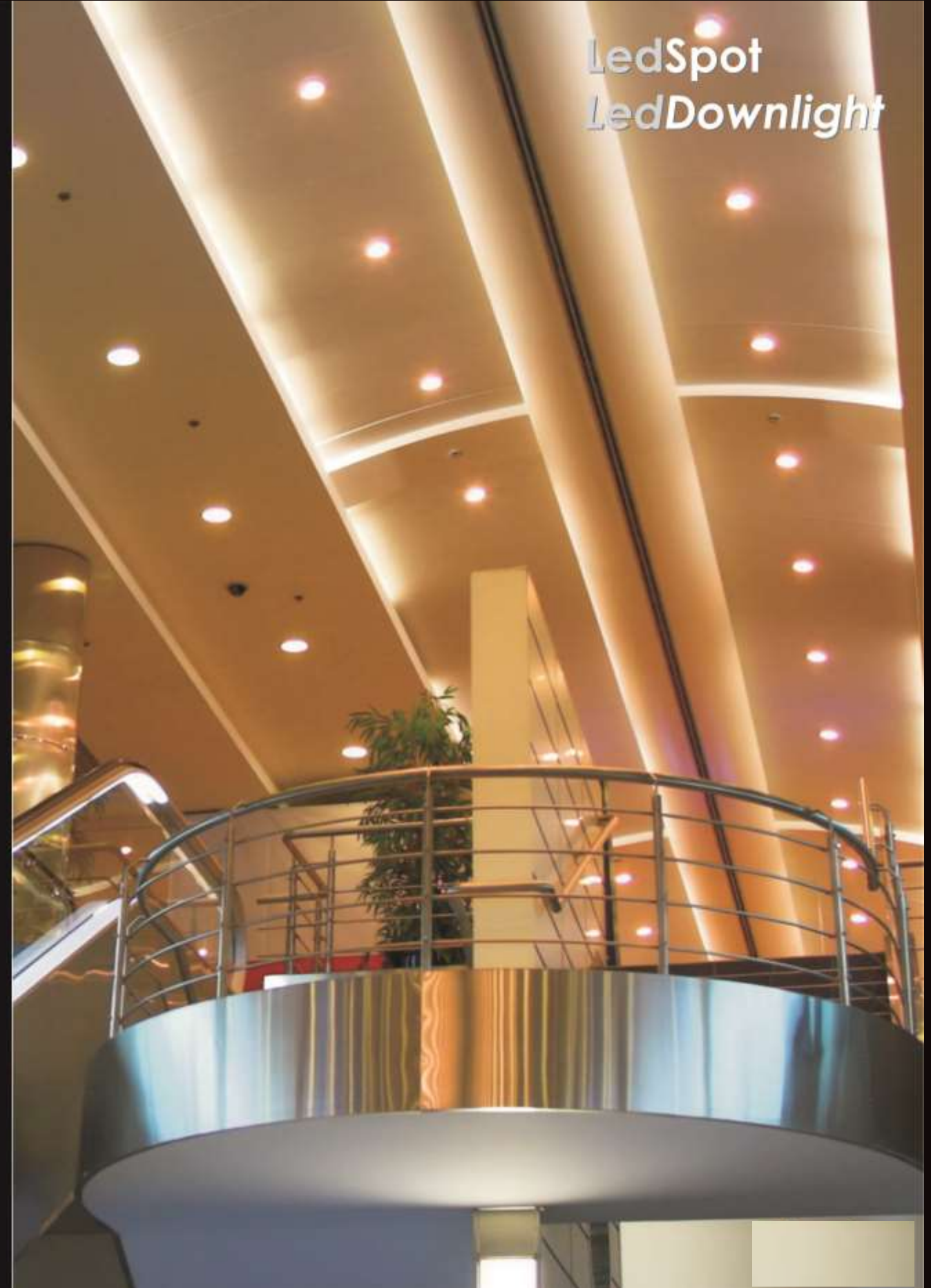

## LedSpot / Downlight

Lsa10004



Montaj / Mounting



Boyutlar / Size



Teknik Bilgiler / Technical Data

<b>Güç / m</b> Power / m	4 W
<b>Işık Akısı / lm</b> Luminous flux	300 lm
<b>Işık Rengi</b> Lighting Color	 2700 K 3000 K 4000 K 5000 K 6500 K
<b>Çalışma Gerilimi</b> Operating Voltage	AC 85V - 265V
<b>Işık Açısı</b> Light Angle	140°
<b>Koruma</b> IP Grade	IP20
<b>Renk Seçenekleri</b> Color Options	Beyaz, Siyah, Metalik / White, Siyah, Metallic
<b>Materyal</b> Material	Alüminyum / Aluminium
<b>Kontrol Seçenekleri</b> Controler Options	DIM ( Triac)
<b>Led</b>	SMD

70

## LedSpot / Downlight

Lsa11006



Montaj / Mounting



Boyutlar / Size



Teknik Bilgiler / Technical Data

<b>Güç / m</b> Power / m	6 W
<b>Işık Akısı / lm</b> Luminous flux	480 lm
<b>Işık Rengi</b> Lighting Color	 2700 K 3000 K 4000 K 5000 K 6500 K
<b>Çalışma Gerilimi</b> Operating Voltage	AC 85V - 265V
<b>Işık Açısı</b> Light Angle	140°
<b>Koruma</b> IP Grade	IP20
<b>Renk Seçenekleri</b> Color Options	Beyaz, Siyah, Metalik / White, Black, Metallic
<b>Materyal</b> Material	Alüminyum / Aluminium
<b>Kontrol Seçenekleri</b> Controler Options	DIM (Triac)
<b>Led</b>	SMD

71



## LedSpot / Downlight

Lsa14010



Montaj / Mounting



Boyutlar / Size

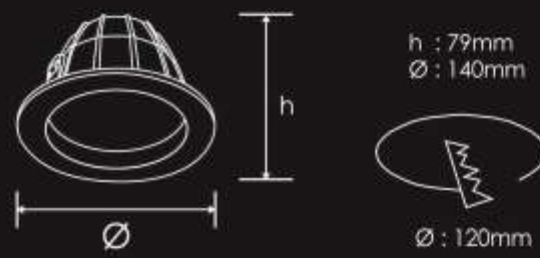

h : 79mm  
Ø : 140mm

Ø : 120mm

Teknik Bilgiler / Technical Data

<b>Güç / m</b> Power / m	10 W
<b>Işık Akısı / lm</b> Luminous flux	780 lm
<b>Işık Rengi</b> Lighting Color	2700 K 3000 K 4000 K 5000 K 6500 K
<b>Çalışma Gerilimi</b> Operating Voltage	AC 85V - 265V
<b>Işık Açısı</b> Light Angle	140°
<b>Koruma</b> IP Grade	IP20
<b>Renk Seçenekleri</b> Color Options	Beyaz, Siyah, Metalik / White, Black, Metallic
<b>Materyal</b> Material	Alüminyum / Aluminium
<b>Kontrol Seçenekleri</b> Controler Options	DIM (Triac)
<b>Led</b>	SMD

72

## LedSpot / Downlight

Lsb5203



Montaj / Mounting



Boyutlar / Size



h : 27mm  
Ø : 52mm

Ø 45mm

Teknik Bilgiler / Technical Data

<b>Güç / m</b> Power / m	3 W
<b>Işık Akısı / lm</b> Luminous flux	180 lm
<b>Işık Rengi</b> Lighting Color	2700 K 3000 K 4000 K 5000 K 6500 K
<b>Çalışma Gerilimi</b> Operating Voltage	AC 85V - 265V
<b>Işık Açısı</b> Light Angle	15° - 24° - 30°
<b>Koruma</b> IP Grade	IP20
<b>Renk Seçenekleri</b> Color Options	Beyaz, Siyah, Metalik / White, Black, Metallic
<b>Materyal</b> Material	Alüminyum / Aluminium
<b>Kontrol Seçenekleri</b> Controler Options	DIM (Triac)
<b>Led</b>	1*3 W

73



## LedSpot / Downlight

Lsb6903



Montaj / Mounting



Boyutlar / Size



Teknik Bilgiler / Technical Data

<b>Güç / m</b> Power / m	3 W
<b>Işık Akısı / lm</b> Luminous flux	640 lm
<b>Işık Rengi</b> Lighting Color	 2700 K 3000 K 4000 K 5000 K 6500 K
<b>Çalışma Gerilimi</b> Operating Voltage	AC 85V - 265V
<b>Işık Açısı</b> Light Angle	30° - 45°
<b>Koruma</b> IP Grade	IP20
<b>Renk Seçenekleri</b> Color Options	Beyaz, Siyah, Metalik / White, Black, Metallic
<b>Materyal</b> Material	Alüminyum / Aluminium
<b>Kontrol Seçenekleri</b> Controler Options	DIM (Triac)
<b>Led</b>	1*3 W

74

## LedSpot / Downlight

Lsb8503



Montaj / Mounting



Boyutlar / Size



Teknik Bilgiler / Technical Data

<b>Güç / m</b> Power / m	3 W
<b>Işık Akısı / lm</b> Luminous flux	240 lm
<b>Işık Rengi</b> Lighting Color	 2700 K 3000 K 4000 K 5000 K 6500 K
<b>Çalışma Gerilimi</b> Operating Voltage	AC 85V - 265V
<b>Işık Açısı</b> Light Angle	30° - 45°
<b>Koruma</b> IP Grade	IP20
<b>Renk Seçenekleri</b> Color Options	Beyaz, Siyah, Metalik / White, Black, Metallic
<b>Materyal</b> Material	Alüminyum / Aluminium
<b>Kontrol Seçenekleri</b> Controler Options	DIM (Triac)
<b>Led</b>	1*3 W

75

## LedSpot / Downlight

Lsb10905



Montaj / Mounting



Boyutlar / Size

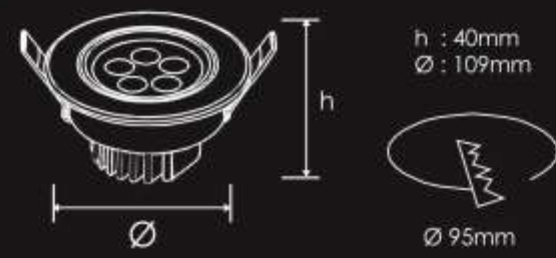

Teknik Bilgiler / Technical Data

<b>Güç / m</b> Power / m	5 W
<b>Işık Akısı / lm</b> Luminous flux	400 lm
<b>Işık Rengi</b> Lighting Color	 2700 K 3000 K 4000 K 5000 K 6500 K
<b>Çalışma Gerilimi</b> Operating Voltage	AC 85V - 265V
<b>Işık Açısı</b> Light Angle	30° - 45°
<b>Koruma</b> IP Grade	IP20
<b>Renk Seçenekleri</b> Color Options	Beyaz, Siyah, Metalik / White, Black, Metallic
<b>Materyal</b> Material	Alüminyum / Aluminium
<b>Kontrol Seçenekleri</b> Controler Options	DIM (Triac)
<b>Led</b>	5*1 W

76

## LedSpot / Downlight

Lsb13909



Montaj / Mounting



Boyutlar / Size



Teknik Bilgiler / Technical Data

<b>Güç / m</b> Power / m	9 W
<b>Işık Akısı / lm</b> Luminous flux	720 lm
<b>Işık Rengi</b> Lighting Color	 2700 K 3000 K 4000 K 5000 K 6500 K
<b>Çalışma Gerilimi</b> Operating Voltage	AC 85V - 265V
<b>Işık Açısı</b> Light Angle	30° - 45°
<b>Koruma</b> IP Grade	IP20
<b>Renk Seçenekleri</b> Color Options	Beyaz, Siyah, Metalik / White, Black, Metallic
<b>Materyal</b> Material	Alüminyum / Aluminium
<b>Kontrol Seçenekleri</b> Controler Options	DIM (Triac)
<b>Led</b>	9*1 W

77



## LedSpot / Downlight

LSC7507



Montaj / Mounting



Boyutlar / Size

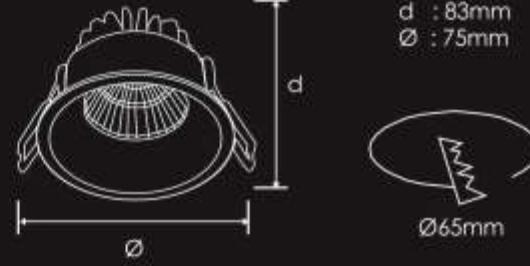

d : 83mm  
Ø : 75mm

Ø65mm

Teknik Bilgiler / Technical Data

<b>Güç / m</b> Power / m	7 W
<b>Işık Akısı / lm</b> Luminous flux	490 lm
<b>Işık Rengi</b> Lighting Color	 2700 K 3000 K 4000 K 5000 K 6500 K
<b>Çalışma Gerilimi</b> Operating Voltage	AC 85V - 265V
<b>Işık Açısı</b> Light Angle	24° - 39°
<b>Koruma</b> IP Grade	IP20
<b>Renk Seçenekleri</b> Color Options	Beyaz, Siyah, Metalik / White, Black, Metallic
<b>Materyal</b> Material	Alüminyum / Aluminium
<b>Kontrol Seçenekleri</b> Controler Options	DIM (Triac)
<b>Led</b>	1*7 W COB

78

## LedSpot / Downlight

LSC7808



Montaj / Mounting



Boyutlar / Size

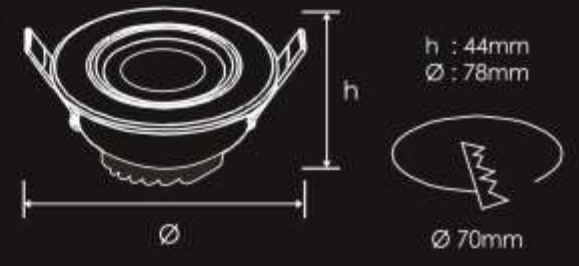

h : 44mm  
Ø : 78mm

Ø70mm

Teknik Bilgiler / Technical Data

<b>Güç / m</b> Power / m	8 W
<b>Işık Akısı / lm</b> Luminous flux	640 lm
<b>Işık Rengi</b> Lighting Color	 2700 K 3000 K 4000 K 5000 K 6500 K
<b>Çalışma Gerilimi</b> Operating Voltage	AC 85V - 265V
<b>Işık Açısı</b> Light Angle	30° - 45° - 60°
<b>Koruma</b> IP Grade	IP20
<b>Renk Seçenekleri</b> Color Options	Beyaz, Siyah, Metalik / White, Black, Metallic
<b>Materyal</b> Material	Alüminyum / Aluminium
<b>Kontrol Seçenekleri</b> Controler Options	DIM (Triac)
<b>Led</b>	1*9 W COB

79



## LedSpot / Downlight

LSC8309



Montaj / Mounting



Boyutlar / Size

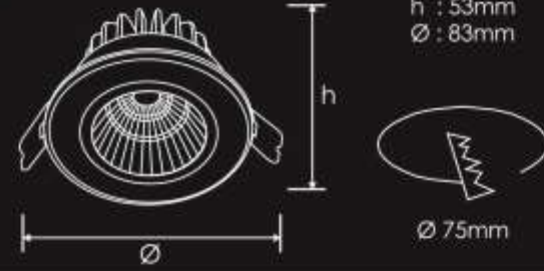

Teknik Bilgiler / Technical Data

<b>Güç / m</b> Power / m	9 W
<b>Işık Akısı / lm</b> Luminous flux	600 lm
<b>Işık Rengi</b> Lighting Color	 2700 K 3000 K 4000 K 5000 K 6500 K
<b>Çalışma Gerilimi</b> Operating Voltage	AC 85V - 265V
<b>Işık Açısı</b> Light Angle	38°
<b>Koruma</b> IP Grade	IP20
<b>Renk Seçenekleri</b> Color Options	Beyaz, Siyah, Metalik / White, Black, Metallic
<b>Materyal</b> Material	Alüminyum / Aluminium
<b>Kontrol Seçenekleri</b> Controler Options	DIM (Triac)
<b>Led</b>	1*9 W COB

## LedSpot / Downlight

LSC9209



Montaj / Mounting



Boyutlar / Size

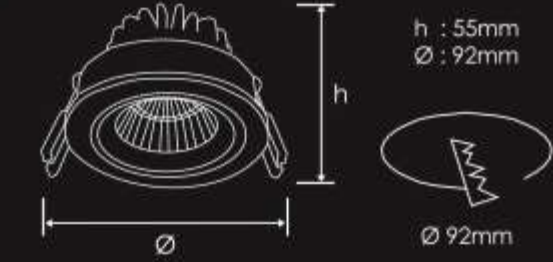

Teknik Bilgiler / Technical Data

<b>Güç / m</b> Power / m	9 W
<b>Işık Akısı / lm</b> Luminous flux	6300 lm
<b>Işık Rengi</b> Lighting Color	 2700 K 3000 K 4000 K 5000 K 6500 K
<b>Çalışma Gerilimi</b> Operating Voltage	AC 85V - 265V
<b>Işık Açısı</b> Light Angle	24° - 39°
<b>Koruma</b> IP Grade	IP20
<b>Renk Seçenekleri</b> Color Options	Beyaz, Siyah, Metalik / White, Black, Metallic
<b>Materyal</b> Material	Alüminyum / Aluminium
<b>Kontrol Seçenekleri</b> Controler Options	DIM (Triac)
<b>Led</b>	1*9 W

## LedSpot / Downlight

LSC10312



Montaj / Mounting



Boyutlar / Size

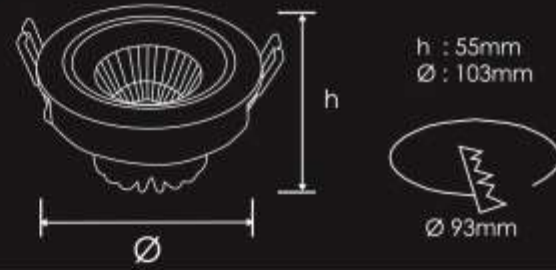

Teknik Bilgiler / Technical Data

<b>Güç / m</b> Power / m	12 W
<b>Işık Akısı / lm</b> Luminous flux	700 lm
<b>Işık Rengi</b> Lighting Color	 2700 K 3000 K 4000 K 5000 K 6500 K
<b>Çalışma Gerilimi</b> Operating Voltage	AC 85V - 265V
<b>Işık Açısı</b> Light Angle	24° - 38°
<b>Koruma</b> IP Grade	IP20
<b>Renk Seçenekleri</b> Color Options	Beyaz / White
<b>Materyal</b> Material	Alüminyum / Aluminium
<b>Kontrol Seçenekleri</b> Controler Options	DIM (Triac)
<b>Led</b>	1*12 W COB

82

## LedSpot / Downlight

LSC11010



Montaj / Mounting



Boyutlar / Size

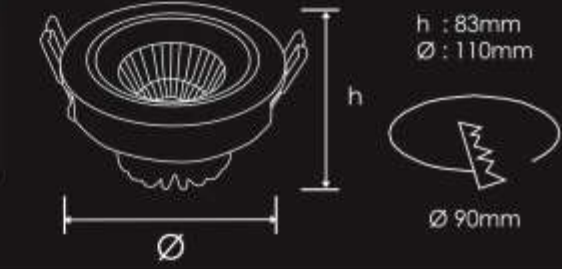

Teknik Bilgiler / Technical Data

<b>Güç / m</b> Power / m	10 W
<b>Işık Akısı / lm</b> Luminous flux	700 lm
<b>Işık Rengi</b> Lighting Color	 2700 K 3000 K 4000 K 5000 K 6500 K
<b>Çalışma Gerilimi</b> Operating Voltage	AC 85V - 265V
<b>Işık Açısı</b> Light Angle	24° - 38°
<b>Koruma</b> IP Grade	IP20
<b>Renk Seçenekleri</b> Color Options	Beyaz, Siyah, Metalik / White, Black, Metallic
<b>Materyal</b> Material	Alüminyum / Aluminium
<b>Kontrol Seçenekleri</b> Controler Options	DIM (Triac)
<b>Led</b>	1*9 W

83



## LedSpot/Downlight

Lsd8010



Montaj / Mounting



Boyutlar / Size



Ø : 80mm  
h : 94 / 127mm



Ø 75mm

Teknik Bilgiler / Technical Data

<b>Güç / m</b> Power / m	10 W
<b>Işık Akısı / lm</b> Luminous flux	550 lm
<b>Işık Rengi</b> Lighting Color	 2700 K 3000 K 4000 K 5000 K 6500 K
<b>Çalışma Gerilimi</b> Operating Voltage	AC 85V - 265V
<b>Işık Açısı</b> Light Angle	24° - 36°
<b>Koruma</b> IP Grade	IP20
<b>Renk Seçenekleri</b> Color Options	Beyaz, Siyah, Metalik, Altın White, Black, Metallic, Gold
<b>Materyal</b> Material	Alüminyum / Aluminium
<b>Kontrol Seçenekleri</b> Controler Options	DIM (Triac)
<b>Led</b>	9 W COB

84

## LedSpot/Downlight



Lsd8010-1E Ø80\*94  
Lsd8010-1F Ø80\*100

Lsd8010-1C Ø80\*94  
Lsd8010-1D Ø80\*100



Lsd8010-1A Ø80\*94  
Lsd8010-1B Ø80\*100

Lsd8010-1G Ø80\*94  
Lsd8010-1H Ø80\*100



Lsd8010-2A  
Ø80\*118

Lsd8010-2B  
Ø80\*118

Lsd8010-2C  
Ø80\*118



Lsd8010-2D  
Ø80\*127

Lsd8010-2E  
Ø80\*127

Lsd8010-2F  
Ø80\*127



## LedSpot/Downlight

Lse14311



Montaj / Mounting



Boyutlar / Size

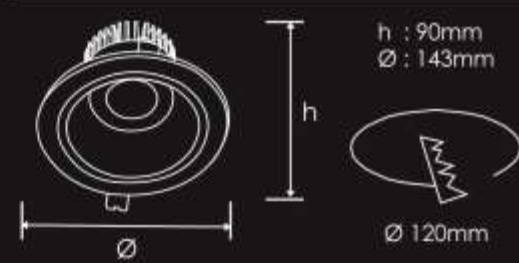

Teknik Bilgiler / Technical Data

<b>Güç / m</b> Power / m	11 W
<b>Işık Akısı / lm</b> Luminous flux	1200 lm
<b>Işık Rengi</b> Lighting Color	 2700 K 3000 K 4000 K 5000 K 6500 K
<b>Çalışma Gerilimi</b> Operating Voltage	AC 85V - 265V
<b>Işık Açısı</b> Light Angle	90°
<b>Koruma</b> IP Grade	IP20
<b>Renk Seçenekleri</b> Color Options	Beyaz, Siyah, Metalik / White, Black, Metallic
<b>Materyal</b> Material	Alüminyum / Aluminium
<b>Kontrol Seçenekleri</b> Controler Options	DIM (Triac)
<b>Led</b>	PH Light

## LedSpot/Downlight

Lse19030



Montaj / Mounting



Boyutlar / Size

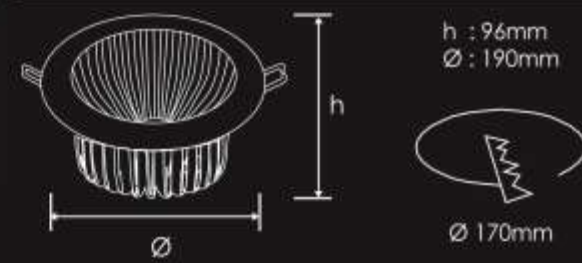

Teknik Bilgiler / Technical Data

<b>Güç / m</b> Power / m	30 W
<b>Işık Akısı / lm</b> Luminous flux	2100 lm
<b>Işık Rengi</b> Lighting Color	 2700 K 3000 K 4000 K 5000 K 6500 K
<b>Çalışma Gerilimi</b> Operating Voltage	AC 85V - 265V
<b>Işık Açısı</b> Light Angle	45°
<b>Koruma</b> IP Grade	IP20
<b>Renk Seçenekleri</b> Color Options	Beyaz, Siyah, Metalik / White, Black, Metallic
<b>Materyal</b> Material	Alüminyum / Aluminium
<b>Kontrol Seçenekleri</b> Controler Options	DIM (Triac)
<b>Led</b>	1*27 W COB



## LedSpot/Downlight

Lse22026



Montaj / Mounting



Tavan  
Ceiling

Boyutlar / Size

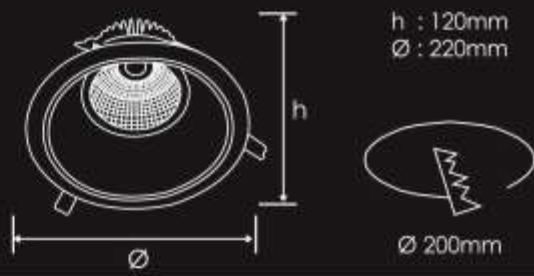

Teknik Bilgiler / Technical Data

<b>Güç / m</b> Power / m	26 W
<b>Işık Akısı / lm</b> Luminous flux	1820 lm
<b>Işık Rengi</b> Lighting Color	 2700 K 3000 K 4000 K 5000 K 6500 K
<b>Çalışma Gerilimi</b> Operating Voltage	AC 85V - 265V
<b>Işık Açısı</b> Light Angle	38°
<b>Koruma</b> IP Grade	IP20
<b>Renk Seçenekleri</b> Color Options	Beyaz, Siyah, Metalik / White, Black, Metallic
<b>Materyal</b> Material	Alüminyum / Aluminium
<b>Kontrol Seçenekleri</b> Controler Options	DIM ( Triac)
<b>Led</b>	1*24 W COB

## LedSpot/Downlight Waterproof

Lsw140



Montaj / Mounting



Tavan  
Ceiling

Boyutlar / Size

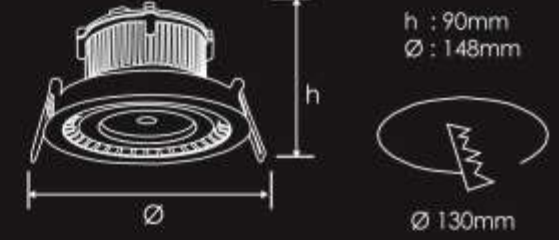

Teknik Bilgiler / Technical Data

<b>Güç / m</b> Power / m	5 W	10 W	15 W	18 W
<b>Işık Akısı / lm</b> Luminous flux	550 lm	1100 lm	1600 lm	2000 lm
<b>Işık Rengi</b> Lighting Color	 2700 K 3000 K 4000 K 5000 K 6500 K RGB			
<b>Çalışma Gerilimi</b> Operating Voltage	AC 85V - 265V			
<b>Işık Açısı</b> Light Angle	30° - 60° - 90° - 120° - 165°			
<b>Koruma</b> IP Grade	IP65			
<b>Renk Seçenekleri</b> Color Options	Beyaz, Siyah, Metalik / White, Black, Metallic			
<b>Materyal</b> Material	Alüminyum / Aluminium			
<b>Kontrol Seçenekleri</b> Controler Options	DIM ( Triac)			
<b>Led</b>	COB			

## LedSpot/Downlight

Lsk8309



Montaj / Mounting



Boyutlar / Size

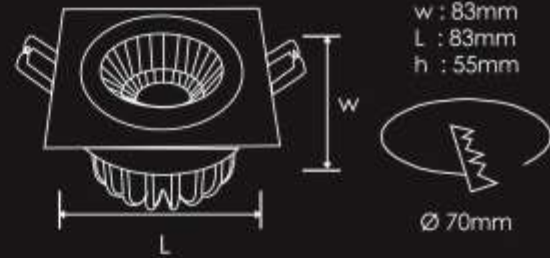

Teknik Bilgiler / Technical Data

<b>Güç / m</b> Power / m	9 W
<b>Işık Akısı / lm</b> Luminous flux	630 lm
<b>Işık Rengi</b> Lighting Color	 2700 K 3000 K 4000 K 5000 K 6500 K
<b>Çalışma Gerilimi</b> Operating Voltage	AC 85V - 265V
<b>Işık Açısı</b> Light Angle	24° - 38°
<b>Koruma</b> IP Grade	IP20
<b>Renk Seçenekleri</b> Color Options	Beyaz, Siyah, Metalik / White, Black, Metallic
<b>Materyal</b> Material	Alüminyum / Aluminium
<b>Kontrol Seçenekleri</b> Controler Options	DIM (Triac)
<b>Led</b>	9 W COB

## LedSpot/Downlight

Lsk10510



Montaj / Mounting



Boyutlar / Size



Teknik Bilgiler / Technical Data

<b>Güç / m</b> Power / m	10 W
<b>Işık Akısı / lm</b> Luminous flux	700 lm
<b>Işık Rengi</b> Lighting Color	 2700 K 3000 K 4000 K 5000 K 6500 K
<b>Çalışma Gerilimi</b> Operating Voltage	AC 85V - 265V
<b>Işık Açısı</b> Light Angle	24° - 38°
<b>Koruma</b> IP Grade	IP20
<b>Renk Seçenekleri</b> Color Options	Beyaz, Siyah, Metalik / White, Black, Metallic
<b>Materyal</b> Material	Alüminyum / Aluminium
<b>Kontrol Seçenekleri</b> Controler Options	DIM (Triac)
<b>Led</b>	1*9 W



## LedSpot/Downlight

Lsk12012



Montaj / Mounting



Boyutlar / Size

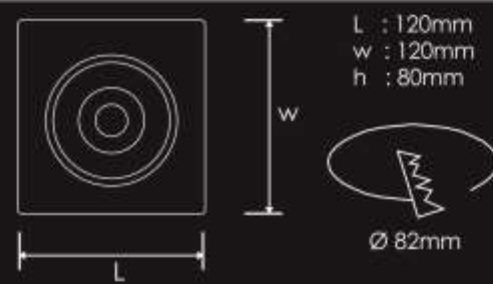

Teknik Bilgiler / Technical Data

<b>Güç / m</b> Power / m	12 W
<b>Işık Akısı / lm</b> Luminous flux	840 lm
<b>Işık Rengi</b> Lighting Color	 2700 K 3000 K 4000 K 5000 K 6500 K
<b>Çalışma Gerilimi</b> Operating Voltage	AC 85V - 265V
<b>Işık Açısı</b> Light Angle	24° - 38°
<b>Koruma</b> IP Grade	IP20
<b>Renk Seçenekleri</b> Color Options	Beyaz, Siyah, Metalik / White, Black, Metallic
<b>Materyal</b> Material	Alüminyum / Aluminium
<b>Kontrol Seçenekleri</b> Controler Options	DIM (Triac)
<b>Led</b>	1*12 W

92

## LedSpot/Downlight

Lsk22020



Montaj / Mounting



Boyutlar / Size

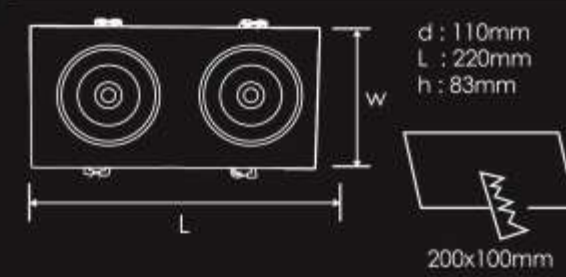

Teknik Bilgiler / Technical Data

<b>Güç / m</b> Power / m	20 W
<b>Işık Akısı / lm</b> Luminous flux	1400 lm
<b>Işık Rengi</b> Lighting Color	 2700 K 3000 K 4000 K 5000 K 6500 K
<b>Çalışma Gerilimi</b> Operating Voltage	AC 85V - 265V
<b>Işık Açısı</b> Light Angle	24° - 38°
<b>Koruma</b> IP Grade	IP20
<b>Renk Seçenekleri</b> Color Options	Beyaz, Siyah, Metalik / White, Black, Metallic
<b>Materyal</b> Material	Alüminyum / Aluminium
<b>Kontrol Seçenekleri</b> Controler Options	DIM (Triac)
<b>Led</b>	2*10 W COB

93



**LedSpot/DownLight**  
SıvaÜstü / Surface



## LedSpotSıvaüstü / DownlightSurface

Lsuk8009



Montaj / Mounting



Boyutlar / Size

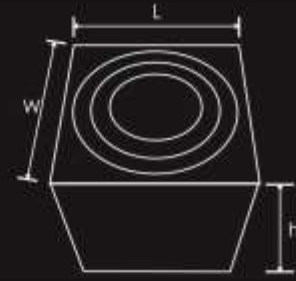

L : 80 mm  
W : 80 mm  
h : 85 mm

Teknik Bilgiler / Technical Data

<b>Güç / m</b> Power / m	9 W
<b>Işık Akısı / lm</b> Luminous flux	740 lm
<b>Işık Rengi</b> Lighting Color	 2700 K 3000 K 4000 K 5000 K 6500 K
<b>Çalışma Gerilimi</b> Operating Voltage	AC 85V - 265V
<b>Işık Açısı</b> Light Angle	24°
<b>Koruma</b> IP Grade	IP20
<b>Renk Seçenekleri</b> Color Options	Beyaz, Siyah, Metalik / White, Black, Metallic
<b>Materyal</b> Material	Alüminyum / Aluminium
<b>Kontrol Seçenekleri</b> Controler Options	DIM (Triac)
<b>Led</b>	1*9 W COB

96

## LedSpotSıvaüstü / DownlightSurface

Lsuk10510



Montaj / Mounting



Boyutlar / Size



L : 105 mm  
W : 105 mm  
h : 135 mm

Teknik Bilgiler / Technical Data

<b>Güç / m</b> Power / m	10 W
<b>Işık Akısı / lm</b> Luminous flux	700 lm
<b>Işık Rengi</b> Lighting Color	 2700 K 3000 K 4000 K 5000 K 6500 K
<b>Çalışma Gerilimi</b> Operating Voltage	AC 85V - 265V
<b>Işık Açısı</b> Light Angle	24° - 38°
<b>Koruma</b> IP Grade	IP20
<b>Renk Seçenekleri</b> Color Options	Beyaz, Siyah, Metalik / White, Black, Metallic
<b>Materyal</b> Material	Alüminyum / Aluminium
<b>Kontrol Seçenekleri</b> Controler Options	DIM (Triac)
<b>Led</b>	1*9 W COB

97

## LedSpotSivaüstü / DownlightSurface

LSU10409



Montaj / Mounting



Boyutlar / Size



Ø : 104mm  
h : 141mm

Teknik Bilgiler / Technical Data

<b>Güç / m</b> Power / m	9 W
<b>Işık Akısı / lm</b> Luminous flux	630 lm
<b>Işık Rengi</b> Lighting Color	 2700 K 3000 K 4000 K 5000 K 6500 K
<b>Çalışma Gerilimi</b> Operating Voltage	AC 85V - 265V
<b>Işık Açısı</b> Light Angle	38°
<b>Koruma</b> IP Grade	IP20
<b>Renk Seçenekleri</b> Color Options	Beyaz, Siyah, Metalik / White, Black, Metallic
<b>Materyal</b> Material	Alüminyum / Aluminium
<b>Kontrol Seçenekleri</b> Controler Options	DIM (Triac)
<b>Led</b>	1*9 W COB

98

## LedSpotSivaüstü / DownlightSurface

LSU17020



Montaj / Mounting



Boyutlar / Size



Ø : 170mm  
h : 180mm

Teknik Bilgiler / Technical Data

<b>Güç / m</b> Power / m	20 W
<b>Işık Akısı / lm</b> Luminous flux	1860 lm
<b>Işık Rengi</b> Lighting Color	 2700 K 3000 K 4000 K 5000 K 6500 K
<b>Çalışma Gerilimi</b> Operating Voltage	AC 85V - 265V
<b>Işık Açısı</b> Light Angle	38°
<b>Koruma</b> IP Grade	IP20
<b>Renk Seçenekleri</b> Color Options	Beyaz, Siyah, Metalik / White, Black, Metallic
<b>Materyal</b> Material	Alüminyum / Aluminium
<b>Kontrol Seçenekleri</b> Controler Options	DIM (Triac)
<b>Led</b>	1*20 W COB

99



## LedRaySpot / TrackLight



## LedRaySpot / TrackLight

Lsr200



### Montaj / Mounting



### Boyutlar / Size



Ø : 110 / 85 mm  
h : 300 / 250 mm  
d : 200 / 170 mm

### Teknik Bilgiler / Technical Data

<b>Güç / m</b> Power / m	20 W	40 W			
<b>Işık Akısı / lm</b> Luminous flux	1800 lm	3500 lm			
<b>Işık Rengi</b> Lighting Color	 2700 K	 3000 K	 4000 K	 5000 K	 6500 K
<b>Çalışma Gerilimi</b> Operating Voltage	AC 85V - 265V				
<b>Işık Açısı</b> Light Angle	15/24/36/60				
<b>Koruma</b> IP Grade	IP20				
<b>Renk Seçenekleri</b> Color Options	Beyaz, Siyah, Metalik / White, Black, Metallic				
<b>Materyal</b> Material	Alüminyum / Aluminium				
<b>Kontrol Seçenekleri</b> Controler Options	DIM (Triac)				
<b>Led</b>	1*20 W COB	1*40 W COB			

## LedRaySpot / TrackLight

Lsr160



Montaj / Mounting



Boyutlar / Size



Teknik Bilgiler / Technical Data

<b>Güç / m</b> Power / m	20 W	30 W	45 W		
<b>Işık Akısı / lm</b> Luminous flux	1800 lm	2200 lm	3500 lm		
<b>Işık Rengi</b> Lighting Color	 2700 K	 3000 K	 4000 K	 5000 K	 6500 K
<b>Çalışma Gerilimi</b> Operating Voltage	AC 85V - 265V				
<b>Işık Açısı</b> Light Angle	15/24/36/60				
<b>Koruma</b> IP Grade	IP20				
<b>Renk Seçenekleri</b> Color Options	Beyaz, Siyah, Metalik / White, Black, Metallic				
<b>Materyal</b> Material	Alüminyum / Aluminium				
<b>Kontrol Seçenekleri</b> Controler Options	DIM (Triac)				
<b>Led</b>	1*20 W COB	1*30 W COB	1*45 W COB		

102

## LedRaySpot / TrackLight

Lsr140



Montaj / Mounting



Boyutlar / Size



Teknik Bilgiler / Technical Data

<b>Güç / m</b> Power / m	25 W	40 W			
<b>Işık Akısı / lm</b> Luminous flux	2000 lm	3200 lm			
<b>Işık Rengi</b> Lighting Color	 2700 K	 3000 K	 4000 K	 5000 K	 6500 K
<b>Çalışma Gerilimi</b> Operating Voltage	AC 85V - 265V				
<b>Işık Açısı</b> Light Angle	15/24/36/60				
<b>Koruma</b> IP Grade	IP20				
<b>Renk Seçenekleri</b> Color Options	Beyaz, Siyah, Metalik / White, Black, Metallic				
<b>Materyal</b> Material	Alüminyum / Aluminium				
<b>Kontrol Seçenekleri</b> Controler Options	DIM (Triac)				
<b>Led</b>	1*25 W COB	1*40 W COB			

103



## LedRaySpot / TrackLight

Lsr185



Montaj / Mounting



Boyutlar / Size

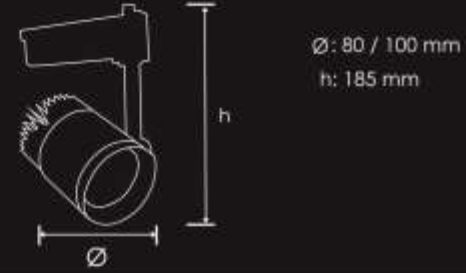

Teknik Bilgiler / Technical Data

<b>Güç / m</b> Power / m	25 W	40 W
<b>Işık Akısı / lm</b> Luminous flux	2000 lm	3200 lm
<b>Işık Rengi</b> Lighting Color	 2700 K 3000 K 4000 K 5000 K 6500 K	
<b>Çalışma Gerilimi</b> Operating Voltage	AC 85V - 265V	
<b>Işık Açısı</b> Light Angle	15/24/36/60	
<b>Koruma</b> IP Grade	IP20	
<b>Renk Seçenekleri</b> Color Options	Beyaz, Siyah, Metalik / White, Black, Metallic	
<b>Materyal</b> Material	Alüminyum / Aluminium	
<b>Kontrol Seçenekleri</b> Controler Options	DIM (Triac)	
<b>Led</b>	1*25 W COB	1*40 W COB

104

## LedRaySpot / TrackLight

Lsr205



Montaj / Mounting



Boyutlar / Size

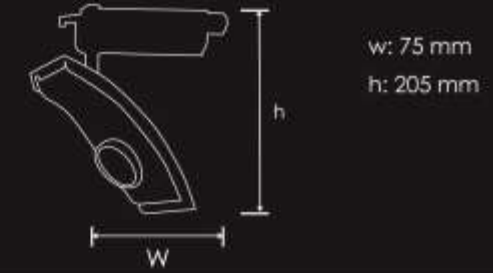

Teknik Bilgiler / Technical Data

<b>Güç / m</b> Power / m	20 W
<b>Işık Akısı / lm</b> Luminous flux	1800 lm
<b>Işık Rengi</b> Lighting Color	 2700 K 3000 K 4000 K 5000 K 6500 K
<b>Çalışma Gerilimi</b> Operating Voltage	AC 85V - 265V
<b>Işık Açısı</b> Light Angle	24/36
<b>Koruma</b> IP Grade	IP20
<b>Renk Seçenekleri</b> Color Options	Beyaz, Siyah, Metalik / White, Black, Metallic
<b>Materyal</b> Material	Alüminyum / Aluminium
<b>Kontrol Seçenekleri</b> Controler Options	DIM (Triac)
<b>Led</b>	1*20 W COB

105



LedSarkit  
*LedPendant*



## ledSarkıt / ledPendant

## Sk1010

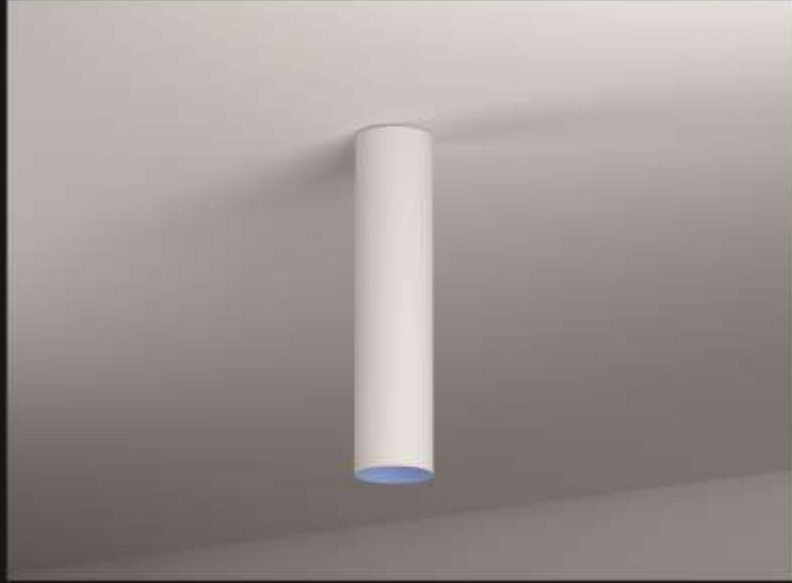

### Montaj / Mounting



### Boyutlar / Size



Ø: 70 / 100 / 140 mm  
h: 400 / 600 / 1000 mm

\*Özel ölçü üretilebilir.  
\*Custom production.

### Teknik Bilgiler / Technical Data

<b>Çalışma Gerilimi</b> Operating Voltage	100 - 240 V
<b>Işık Led Ampul Duy Modeli</b> Lamp Base	E27
<b>Yüzey Dokusu</b> Surface Texture	Mat, Parlak, Saten Matt, Polished, Satine
<b>Işık Rengi</b> Lighting Color	 2700 K 3000 K 4000 K 5000 K 6500 K RGB
<b>Renk Seçenekleri</b> Color Options	Tüm Alüminyum Eloksal Renkleri / All colors of electro - anodizing Tüm Elektrostatik Toz Boya Renkleri / All colors of electrostatic powder coating
<b>Kontrol Seçenekleri</b> Controler Options	DALI, DIM (0-10 V, PWM, Resistor, Triac, Touch)
<b>Çalışma Sıcaklığı</b> Operating Temp.	-25°C - +60°C

## ledSarkıt / ledPendant

## Sk1011



### Montaj / Mounting



### Boyutlar / Size

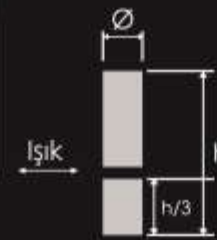

Ø: 70 / 100 / 140 mm  
h: 400 / 600 / 1000 mm

\*Özel ölçü üretilebilir.  
\*Custom production.

### Teknik Bilgiler / Technical Data

<b>Çalışma Gerilimi</b> Operating Voltage	100 - 240 V
<b>Işık Led Ampul Duy Modeli</b> Lamp Base	E27
<b>Yüzey Dokusu</b> Surface Texture	Mat, Parlak, Saten Matt, Polished, Satine
<b>Işık Rengi</b> Lighting Color	 2700 K 3000 K 4000 K 5000 K 6500 K RGB
<b>Renk Seçenekleri</b> Color Options	Tüm Alüminyum Eloksal Renkleri / All colors of electro - anodizing Tüm Elektrostatik Toz Boya Renkleri / All colors of electrostatic powder coating
<b>Kontrol Seçenekleri</b> Controler Options	DALI, DIM (0-10 V, PWM, Resistor, Triac, Touch)
<b>Çalışma Sıcaklığı</b> Operating Temp.	-25°C - +60°C

## ledSarkıt / ledPendant

## Sk1020



### Montaj / Mounting



### Boyutlar / Size



Ø: 70 / 100 / 140 mm  
h: 400 / 600 / 1000 mm

\*Özel ölçü üretilebilir.  
\*Custom production.

### Teknik Bilgiler / Technical Data

<b>Çalışma Gerilimi</b> Operating Voltage	100 - 240 V
<b>Işık Led Ampul Duy Modeli</b> Lamp Base	E27
<b>Yüzey Dokusu</b> Surface Texture	Mat, Parlak, Saten Matt, Polished, Satine
<b>Işık Rengi</b> Lighting Color	2700 K 3000 K 4000 K 5000 K 6500 K RGB
<b>Renk Seçenekleri</b> Color Options	Tüm Alüminyum Eloksal Renkleri / All colors of electro - anodizing Tüm Elektrostatik Toz Boya Renkleri / All colors of electrostatic powder coating
<b>Kontrol Seçenekleri</b> Controler Options	DALI, DIM (0-10 V, PWM, Resistor, Triac, Touch)
<b>Çalışma Sıcaklığı</b> Operating Temp.	-25°C - +60°C

## ledSarkıt / ledPendant

## Sk1021

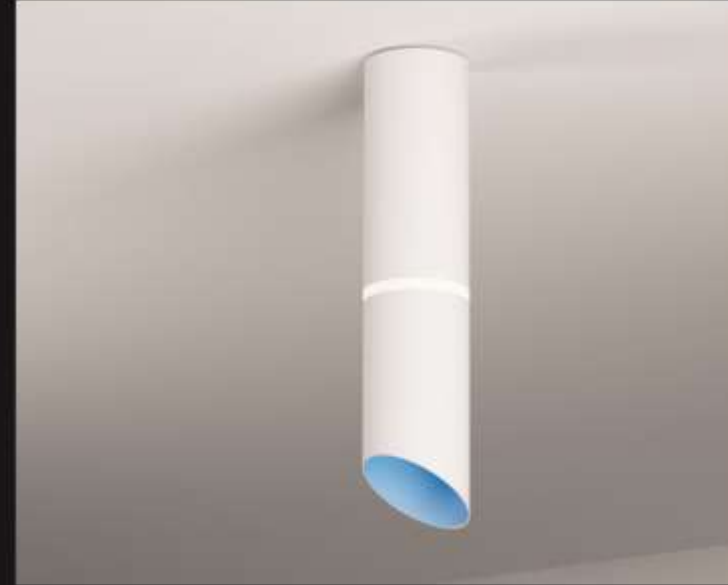

### Montaj / Mounting



### Boyutlar / Size

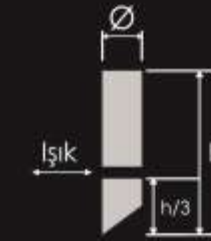

Ø: 70 / 100 / 140 mm  
h: 400 / 600 / 1000 mm

\*Özel ölçü üretilebilir.  
\*Custom production.

### Teknik Bilgiler / Technical Data

<b>Çalışma Gerilimi</b> Operating Voltage	100 - 240 V
<b>Işık Led Ampul Duy Modeli</b> Lamp Base	E27
<b>Yüzey Dokusu</b> Surface Texture	Mat, Parlak, Saten Matt, Polished, Satine
<b>Işık Rengi</b> Lighting Color	2700 K 3000 K 4000 K 5000 K 6500 K RGB
<b>Renk Seçenekleri</b> Color Options	Tüm Alüminyum Eloksal Renkleri / All colors of electro - anodizing Tüm Elektrostatik Toz Boya Renkleri / All colors of electrostatic powder coating
<b>Kontrol Seçenekleri</b> Controler Options	DALI, DIM (0-10 V, PWM, Resistor, Triac, Touch)
<b>Çalışma Sıcaklığı</b> Operating Temp.	-25°C - +60°C



## ledSarkit / ledPendant

Sk2010



Montaj / Mounting



Boyutlar / Size



Ø: 80 mm  
h: 400 mm

\*Özel ölçü üretilebilir.  
\*Custom production.

Teknik Bilgiler / Technical Data

<b>Çalışma Gerilimi</b> Operating Voltage	100 - 240 V
<b>Işık Led Ampul Duy Modeli</b> Lamp Base	E27
<b>Yüzey Dokusu</b> Surface Texture	Mat, Parlak, Saten Matt, Polished, Satine
<b>Işık Rengi</b> Lighting Color	 2700 K 3000 K 4000 K 5000 K 6500 K RGB
<b>Renk Seçenekleri</b> Color Options	Tüm Alüminyum Eloksal Renkleri / All colors of electro - anodizing Tüm Elektrostatik Toz Boya Renkleri / All colors of electrostatic powder coating
<b>Kontrol Seçenekleri</b> Controler Options	DALI, DIM (0-10 V, PWM, Resistor, Triac, Touch)
<b>Çalışma Sıcaklığı</b> Operating Temp.	-25°C - +60°C



ledAmpul / ledLamp

## LedAmpul / LedLamp

Lap7307



Montaj / Mounting



Boyutlar / Size



h : 45mm  
Ø : 73mm

Teknik Bilgiler / Technical Data

<b>Güç / m</b> Power / m	7 W
<b>Işık Akısı / lm</b> Luminous flux	550 lm
<b>Işık Rengi</b> Lighting Color	 2700 K 3000 K 4000 K 5000 K 6500 K
<b>Çalışma Gerilimi</b> Operating Voltage	AC 85V - 265V
<b>Işık Açısı</b> Light Angle	270°
<b>Koruma</b> IP Grade	IP20
<b>Renk Seçenekleri</b> Color Options	Beyaz, Siyah, Metalik / White, Black, Metallic
<b>Materyal</b> Material	Alüminyum + PC + Clas / Aluminium + PC + Clas
<b>Kontrol Seçenekleri</b> Controler Options	DIM (Triac)
<b>Duy</b> Lamp Base	E27

## LedAmpul / LedLamp

Lap6507



Montaj / Mounting



Boyutlar / Size

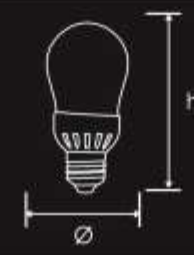

h : 115mm  
Ø : 65mm

Teknik Bilgiler / Technical Data

<b>Güç / m</b> Power / m	7 W
<b>Işık Akısı / lm</b> Luminous flux	420 lm
<b>Işık Rengi</b> Lighting Color	 2700 K 3000 K 4000 K 5000 K 6500 K
<b>Çalışma Gerilimi</b> Operating Voltage	AC 85V - 265V
<b>Işık Açısı</b> Light Angle	140°
<b>Koruma</b> IP Grade	IP20
<b>Renk Seçenekleri</b> Color Options	Beyaz, Siyah, Metalik / White, Black, Metallic
<b>Materyal</b> Material	Seramik + Cam Kapak / Ceramic + Glass cover
<b>Kontrol Seçenekleri</b> Controler Options	DIM (Triac)
<b>Duy</b> Lamp Base	E27



## LedAmpul / LedLamp

Lap6005



Montaj / Mounting



Boyutlar / Size

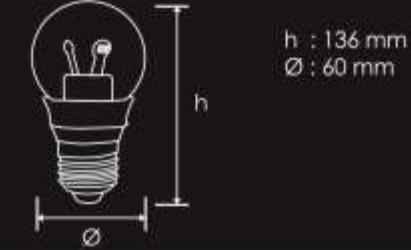

Teknik Bilgiler / Technical Data

<b>Güç / m</b> Power / m	5 W
<b>Işık Akısı / lm</b> Luminous flux	400 lm
<b>Işık Rengi</b> Lighting Color	 2700 K 3000 K 4000 K 5000 K 6500 K
<b>Çalışma Gerilimi</b> Operating Voltage	AC 85V - 265V
<b>Işık Açısı</b> Light Angle	330°
<b>Koruma</b> IP Grade	IP20
<b>Renk Seçenekleri</b> Color Options	Metalik, Altın Metallic, Gold
<b>Materyal</b> Material	Alüminyum + Cam / Aluminium + Glass
<b>Kontrol Seçenekleri</b> Controler Options	DIM (Triac)
<b>Duy</b> Lamp Base	E27

116

## LedAmpul / LedLamp

Lap5003



Montaj / Mounting



Boyutlar / Size

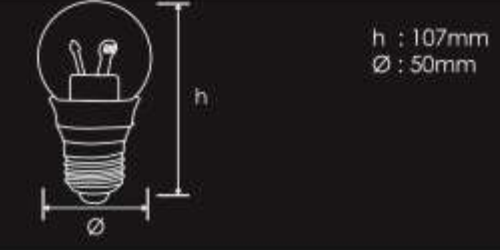

Teknik Bilgiler / Technical Data

<b>Güç / m</b> Power / m	3 W
<b>Işık Akısı / lm</b> Luminous flux	210 lm
<b>Işık Rengi</b> Lighting Color	 2700 K 3000 K 4000 K 5000 K 6500 K
<b>Çalışma Gerilimi</b> Operating Voltage	AC 85V - 265V
<b>Işık Açısı</b> Light Angle	330°
<b>Koruma</b> IP Grade	IP20
<b>Renk Seçenekleri</b> Color Options	Metalik, Altın Metallic, Gold
<b>Materyal</b> Material	Alüminyum + Cam / Aluminium + Glass
<b>Kontrol Seçenekleri</b> Controler Options	DIM (Triac)
<b>Duy</b> Lamp Base	E27

117

## LedAmpul / LedLamp



## Lap4503



### Montaj / Mounting



### Boyutlar / Size



h :78mm  
Ø :45mm

<b>Güç / m</b> Power / m	3 W
<b>Işık Akısı / lm</b> Luminous flux	210 lm
<b>Işık Rengi</b> Lighting Color	 2700 K 3000 K 4000 K 5000 K 6500 K
<b>Çalışma Gerilimi</b> Operating Voltage	AC 85V - 265V
<b>Işık Açısı</b> Light Angle	180°
<b>Koruma</b> IP Grade	IP20
<b>Renk Seçenekleri</b> Color Options	Beyaz / White
<b>Materyal</b> Material	Seramik + Cam / Ceramic + Glass
<b>Kontrol Seçenekleri</b> Controler Options	DIM (Triac)
<b>Duy</b> Lamp Base	E27

## LedAmpul / LedLamp



## Lap3803



### Montaj / Mounting



### Boyutlar / Size



h : 108mm  
Ø : 38mm

### Teknik Bilgiler / Technical Data

<b>Güç / m</b> Power / m	3 W
<b>Işık Akısı / lm</b> Luminous flux	210 lm
<b>Işık Rengi</b> Lighting Color	 2700 K 3000 K 4000 K 5000 K 6500 K
<b>Çalışma Gerilimi</b> Operating Voltage	AC 85V - 265V
<b>Işık Açısı</b> Light Angle	180°
<b>Koruma</b> IP Grade	IP20
<b>Renk Seçenekleri</b> Color Options	Beyaz / White
<b>Materyal</b> Material	Seramik + Cam / Ceramic + Glass
<b>Kontrol Seçenekleri</b> Controler Options	DIM (Triac)
<b>Duy</b> Lamp Base	E14



## LedAmpul / LedLamp



### Montaj / Mounting



### Boyutlar / Size



### Teknik Bilgiler / Technical Data

<b>Güç / m</b> Power / m	3 W
<b>Işık Akısı / lm</b> Luminous flux	240 lm
<b>Işık Rengi</b> Lighting Color	2700 K 3000 K 4000 K 5000 K 6500 K
<b>Çalışma Gerilimi</b> Operating Voltage	AC 85V - 265V
<b>Işık Açısı</b> Light Angle	330°
<b>Koruma</b> IP Grade	IP20
<b>Renk Seçenekleri</b> Color Options	Beyaz / White
<b>Materyal</b> Material	Alüminyum + Cam / Aluminium + Glass
<b>Kontrol Seçenekleri</b> Controler Options	DIM (Triac)
<b>Duy</b> Lamp Base	E14

## Lap3503

## LedAmpul / LedLamp



## Par

### Montaj / Mounting



### Boyutlar / Size

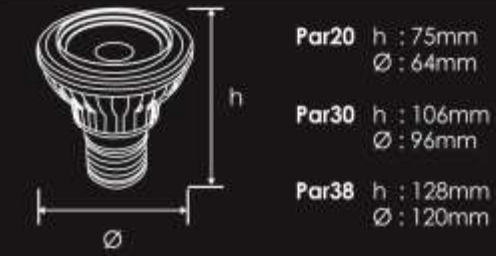

### Teknik Bilgiler / Technical Data

<b>Güç / m</b> Power / m	9 W	15 W	23 W
<b>Işık Akısı / lm</b> Luminous flux	630 lm	1200 lm	1800 lm
<b>Işık Rengi</b> Lighting Color	2700 K 3000 K 4000 K 5000 K 6500 K		
<b>Çalışma Gerilimi</b> Operating Voltage	AC 85V - 265V		
<b>Işık Açısı</b> Light Angle	24° - 36° - 60°		
<b>Koruma</b> IP Grade	IP20		
<b>Renk Seçenekleri</b> Color Options	Siyah / Black		
<b>Materyal</b> Material	Alüminyum / Aluminium		
<b>Kontrol Seçenekleri</b> Controler Options	DIM (Triac)		
<b>Duy</b> Lamp Base	E27		

## LedAmpul / LedLamp

Lmr5008



### Montaj / Mounting



### Boyutlar / Size



h : 70mm  
Ø : 50mm

### Teknik Bilgiler / Technical Data

<b>Güç / m</b> Power / m	8 W
<b>Işık Akısı / lm</b> Luminous flux	640 lm
<b>Işık Rengi</b> Lighting Color	 2700 K 3000 K 4000 K 5000 K 6500 K
<b>Çalışma Gerilimi</b> Operating Voltage	AC 85V - 265V
<b>Işık Açısı</b> Light Angle	30° - 45° - 60°
<b>Koruma</b> IP Grade	IP20
<b>Renk Seçenekleri</b> Color Options	Beyaz, Siyah White, Black
<b>Materyal</b> Material	Alüminyum / Aluminium
<b>Kontrol Seçenekleri</b> Controler Options	DIM (Triac)
<b>Duy</b> Lamp Base	Mr16

## LedAmpul / LedLamp

Lmr5005



### Montaj / Mounting



### Boyutlar / Size



h : 50mm  
Ø : 50mm

### Teknik Bilgiler / Technical Data

<b>Güç / m</b> Power / m	5 W
<b>Işık Akısı / lm</b> Luminous flux	480 lm
<b>Işık Rengi</b> Lighting Color	 2700 K 3000 K 4000 K 5000 K 6500 K
<b>Çalışma Gerilimi</b> Operating Voltage	AC 85V - 265V
<b>Işık Açısı</b> Light Angle	30° - 45° - 60°
<b>Koruma</b> IP Grade	IP20
<b>Renk Seçenekleri</b> Color Options	Siyah, Beyaz Black, White
<b>Materyal</b> Material	Alüminyum / Aluminium
<b>Kontrol Seçenekleri</b> Controler Options	DIM (Triac)
<b>Duy</b> Lamp Base	Mr16





ledFloresan / ledFluorescent



## LedFloresan / LedFluorescent

Lft5



Montaj / Mounting



Boyutlar / Size



Teknik Bilgiler / Technical Data

<b>Güç / m</b> Power / m	7 W	12 W			
<b>Işık Akısı / lm</b> Luminous flux	560 lm	1200 lm			
<b>Işık Rengi</b> Lighting Color	 2700 K	 3000 K	 4000 K	 5000 K	 6500 K
<b>Işık Açısı</b> Light Angle	140°				
<b>Koruma</b> IP Grade	IP20				
<b>Materyal</b> Material	Alüminyum + PC cover / Aluminium + PC cover				
<b>Led</b>	2835				

## LedFloresan / LedFluorescent

Lft8



Montaj / Mounting



Boyutlar / Size

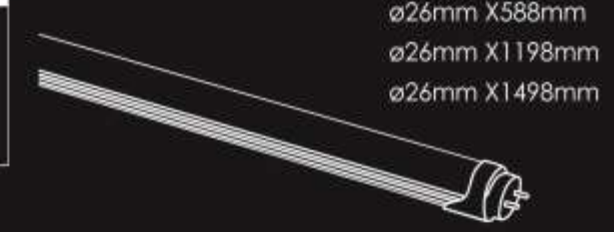

Teknik Bilgiler / Technical Data

<b>Güç / m</b> Power / m	8 W	16 W	22 W		
<b>Işık Akısı / lm</b> Luminous flux	680 lm	1400 lm	2000 lm		
<b>Işık Rengi</b> Lighting Color	 2700 K	 3000 K	 4000 K	 5000 K	 6500 K
<b>Işık Açısı</b> Light Angle	140°				
<b>Koruma</b> IP Grade	IP20				
<b>Materyal</b> Material	Alüminyum + PC cover / Aluminium + PC cover				
<b>Led</b>	2835				



DışMekan / Outdoor



DışMekan / Outdoor

Dm1010



Montaj / Mounting

Boyutlar / Size



Ø : 70 / 100 / 140 mm  
h : 400 / 600 / 1000 mm

\*Özel ölçü üretilebilir. (max. 4 metre)  
\*Custom production. (max. 4 metre)

Teknik Bilgiler / Technical Data

<b>Çalışma Gerilimi</b> Operating Voltage	100 - 240 V
<b>Işık Rengi</b> Lighting Color	 2700 K 3000 K 4000 K 5000 K 6500 K RGB
<b>Yüzey Dokusu</b> Surface Texture	Mat, Parlak, Saten Matt, Polished, Satine
<b>Renk Seçenekleri</b> Color Options	Tüm Alüminyum Elksal Renkleri / All colors of electro - anodizing Tüm Elektrostatik Toz Boya Renkleri / All colors of electrostatic powder coating Tüm Ahşap Desenleri / All types of wood patterns
<b>Kontrol Seçenekleri</b> Controler Options	DALI, DIM (0-10 V, PWM, Resistor, Triac)
<b>Çalışma Sıcaklığı</b> Working Temperature	-25°C - +60°C

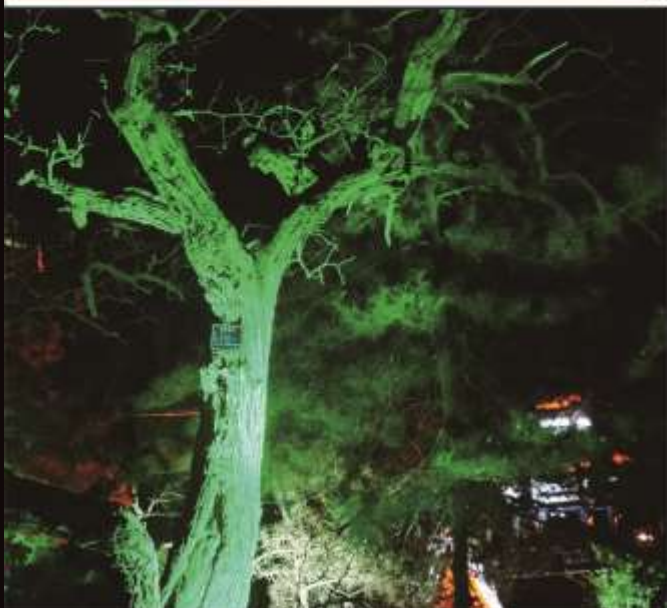



## Dış Mekan / Outdoor

## Dm1050



Montaj / Mounting

Boyutlar / Size



Ø: 100 / 150 mm  
h : 5000 mm  
L : 1000 mm

\*Özel ölçü üretilebilir.(max. 4 metre)  
\*Custom production.(max. 4 metre)

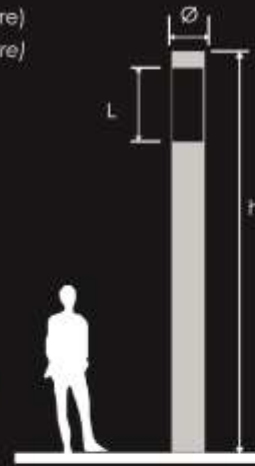

### Teknik Bilgiler / Technical Data

<b>Çalışma Gerilimi</b> Operating Voltage	100 - 240 V
<b>Işık Rengi</b> Lighting Color	 2700 K 3000 K 4000 K 5000 K 6500 K RGB
<b>Yüzey Dokusu</b> Surface Texture	Mat, Parlak, Saten Matt, Polished, Satine
<b>Renk Seçenekleri</b> Color Options	Tüm Alüminyum Eloksal Renkleri / All colors of electro - anodizing Tüm Elektrostatik Toz Boya Renkleri / All colors of electrostatic powder coating Tüm Ahşap Desenleri / All types of wood patterns
<b>Kontrol Seçenekleri</b> Controler Options	DALI, DIM (0-10 V, PWM, Resistor, Triac)
<b>Çalışma Sıcaklığı</b> Working Temperature	-25°C - +60°C

## Bahçe Aydınlatmaları / Garden Lighting

## DbS10



Montaj / Mounting

Boyutlar / Size



Ø : 150 mm  
h : 300 mm

### Teknik Bilgiler / Technical Data

<b>Işık Akısı / lm</b> Luminous flux	100 lm/W
<b>Işık Rengi</b> Lighting Color	 2700 K 3000 K 4000 K 5000 K 6500 K RGB
<b>Çalışma Gerilimi</b> Operating Voltage	100 - 265 V
<b>Işık Açısı</b> Light Angle	60° - 160°
<b>Koruma</b> IP Grade	IP67
<b>Kullanım Alanları</b> Mounting Options	Arazi, Dış Mekan, Genel Aydınlatma Land, Outdoor, General Lighting
<b>Güç Seçenekleri</b> Power Options	5W - 10W - 15W - 20W - 40W - 50W - 80W - 100W - 120W - 150W - 200W



## Bahçe Aydınlatmaları / Garden Lighting

DbS20



Ürün Detay / Product Detail



Boyutlar / Size

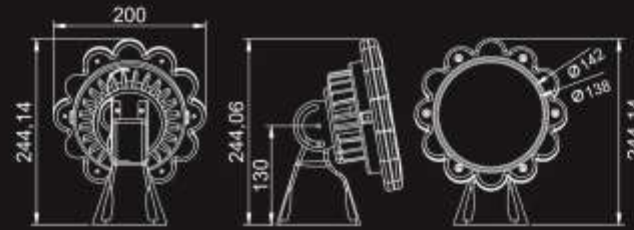

Teknik Bilgiler / Technical Data

<b>Led Adedi</b> Led Quantity	18	3x12 RGB
<b>Güç</b> Power	18 W	36 W
<b>Çalışma Gerilimi</b> Operating Voltage	AC 220V / DC 24V	
<b>Çalışma Sıcaklığı</b> Operating Temp.	-20°C +55°C	
<b>Işık Rengi</b> Lighting Color	 2700 K 3000 K 4000 K 5000 K 6500 K RGB	
<b>Led Açısı</b> Led Angle	15° - 25° - 45° - 60°	
<b>Koruma</b> IP Grade	IP65	
<b>Kontrol Seçenekleri</b> Control Options	DMX512-01KHD	
<b>Boyutlar</b> Size	200*244*180	

## Bahçe Aydınlatmaları / Garden Lighting

DbS30



Boyutlar / Size

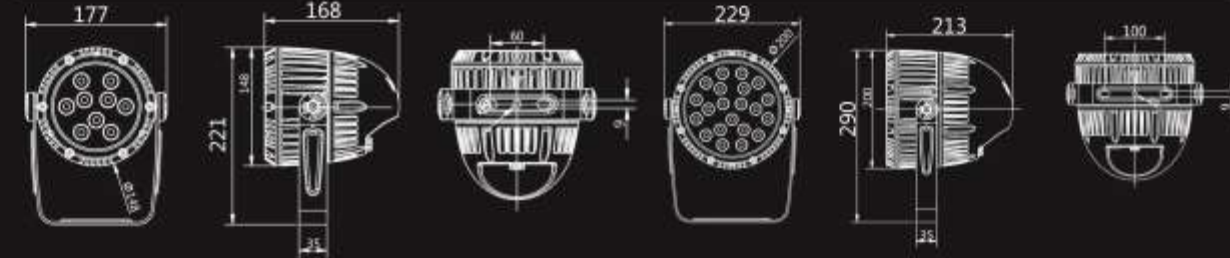

Teknik Bilgiler / Technical Data

<b>Led Adedi</b> Led Quantity	9	21
<b>Güç</b> Power	27 W	63 W
<b>Çalışma Gerilimi</b> Operating Voltage	AC 220V / DC 24V	
<b>Çalışma Sıcaklığı</b> Operating Temp.	-20°C +55°C	
<b>Işık Rengi</b> Lighting Color	 2700 K 3000 K 4000 K 5000 K 6500 K RGB	
<b>Led Açısı</b> Led Angle	15° - 25° - 45° - 60°	
<b>Koruma</b> IP Grade	IP65	
<b>Kontrol Seçenekleri</b> Control Options	DMX512 (1990)	
<b>Boyutlar</b> Size	177*168*221	213*229*290



## Bahçe Aydınlatmaları / Garden Lighting



## DbS40



### Ürün Detay / Product Detail



### Boyutlar / Size

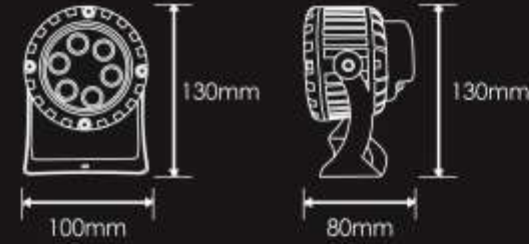

### Teknik Bilgiler / Technical Data

<b>Led Adedi</b> Led Quantity	48
<b>Güç</b> Power	48 W
<b>Çalışma Gerilimi</b> Operating Voltage	AC 220V / DC 24V
<b>Çalışma Sıcaklığı</b> Operating Temp.	-20°C +50°C
<b>Led Açısı</b> Led Angle	15° - 25° - 45° - 60°
<b>Işık Rengi</b> Lighting Color	 2700 K 3000 K 4000 K 5000 K 6500 K RGB
<b>Koruma</b> IP Grade	IP65
<b>Kontrol Seçenekleri</b> Control Options	DMX512(1990)
<b>Boyutlar</b> Size	406*206*223

## Yeraltı Aydınlatma / Underground Lighting

## Dug



### Ürün Modelleri / Product Model



### Teknik Bilgiler / Technical Data

<b>Güç</b> Power	1 - 30 W
<b>Çalışma Gerilimi</b> Operating Voltage	AC 85 - 265V/ DC 12 - 48V
<b>Çalışma Sıcaklığı</b> Operating Temp.	-20°C +50°C
<b>Led Açısı</b> Led Angle	60° - 160°
<b>Işık Rengi</b> Lighting Color	 2700 K 3000 K 4000 K 5000 K 6500 K RGB
<b>Koruma</b> IP Grade	IP67
<b>Kontrol Seçenekleri</b> Control Options	DMX512



## Sualtı Aydınlatma / Underwater Lighting

DuW



Duw11

Ürün Modelleri / Product Model



Duw30



Duw20



Duw13



Duw12

Teknik Bilgiler / Technical Data

<b>Güç</b> Power	1 - 30 W
<b>Çalışma Gerilimi</b> Operating Voltage	AC 85 - 265V / DC 12 - 48V
<b>Çalışma Sıcaklığı</b> Operating Temp.	-20°C +50°C
<b>Led Açısı</b> Led Angle	60° - 160°
<b>Işık Rengi</b> Lighting Color	 2700 K 3000 K 4000 K 5000 K 6500 K RGB
<b>Koruma</b> IP Grade	IP68
<b>Kontrol Seçenekleri</b> Control Options	DMX512

## Led Projektör / Floodlight





## LedProjektör/LedFloodlight

Pra



Montaj / Mounting

Boyutlar / Size



Teknik Bilgiler / Technical Data

<b>Işık Akısı / lm</b> Luminous flux	100 lm/W
<b>Işık Rengi</b> Lighting Color	2700 K 3000 K 4000 K 5000 K 6500 K RGB
<b>Çalışma Gerilimi</b> Operating Voltage	100 - 265 V
<b>Işık Açısı</b> Light Angle	60° - 160°
<b>Koruma</b> IP Grade	IP67
<b>Kullanım Alanları</b> Mounting Options	Cephe, saha ve reklam aydınlatmaları Facade, area and sign lighting
<b>Güç Seçenekleri</b> Power Options	20W - 40W - 50W - 80W - 100W - 120W - 150W - 200W - 300W

## LedProjektör/LedFloodlight

Prb



Montaj / Mounting

Boyutlar / Size

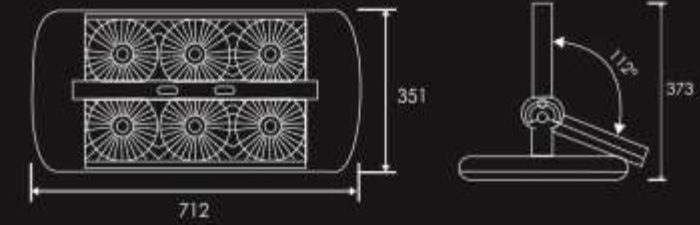

Teknik Bilgiler / Technical Data

<b>Işık Akısı / lm</b> Luminous flux	100 lm/W
<b>Işık Rengi</b> Lighting Color	2700 K 3000 K 4000 K 5000 K 6500 K RGB
<b>Çalışma Gerilimi</b> Operating Voltage	AC 100 V - 240 V
<b>Işık Açısı</b> Light Angle	60° - 100°
<b>Koruma</b> IP Grade	Ip65
<b>Kullanım Alanları</b> Mounting Options	Cephe, saha ve reklam aydınlatmaları Facade, area and sign lighting
<b>Güç Seçenekleri</b> Power Options	240 W - 300 W - 360W



## Yol Aydınlatmaları / Road Lighting



Montaj / Mounting

Boyutlar / Size



### Teknik Bilgiler / Technical Data

<b>Işık Akısı / lm</b> Luminous flux	100 lm/W
<b>Işık Rengi</b> Lighting Color	 2700 K - 3000 K - 4000 K - 5000 K - 6500 K - RGB
<b>Çalışma Gerilimi</b> Operating Voltage	100 - 265 V
<b>Işık Açısı</b> Light Angle	60° - 160°
<b>Koruma</b> IP Grade	IP67
<b>Kullanım Alanları</b> Mounting Options	Sokak, Otoyol, Açık Alan Black, Street, Highway, Open Space
<b>Güç Seçenekleri</b> Power Options	20W - 50W - 80W - 100W - 120W - 150W - 200W - 240W - 300W - 360W

Pyl

## Tünel Aydınlatmaları / Tunnel Lighting



Montaj / Mounting

Boyutlar / Size

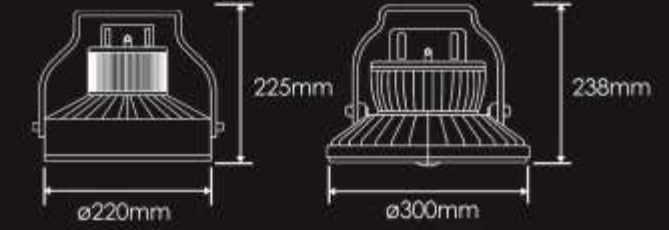

### Teknik Bilgiler / Technical Data

<b>Işık Akısı / lm</b> Luminous flux	100 lm/W
<b>Işık Rengi</b> Lighting Color	 2700 K - 3000 K - 4000 K - 5000 K - 6500 K - RGB
<b>Çalışma Gerilimi</b> Operating Voltage	100 - 265 V
<b>Işık Açısı</b> Light Angle	60° - 160°
<b>Koruma</b> IP Grade	IP67
<b>Kullanım Alanları</b> Mounting Options	Otoyol Tüneli, Raylı Taşıma Tüneli, Metro İstasyonları Highway tunnels, Rail transport in tunnels, Metro stations
<b>Güç Seçenekleri</b> Power Options	50W - 60W - 70W - 80W - 90W - 100W - 110W - 120W - 130W - 140W - 150W - 160W - 170W - 180W - 190W - 200W

## Sanayi Aydınlatmaları / Industrial Lighting

Psn



Montaj / Mounting

Boyutlar / Size

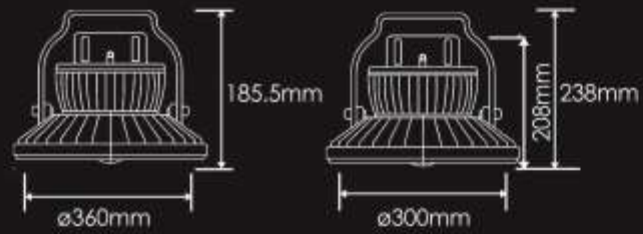

Teknik Bilgiler / Technical Data

<b>Işık Akısı / lm</b> Luminous flux	100 lm/W
<b>Işık Rengi</b> Lighting Color	2700 K 3000 K 4000 K 5000 K 6500 K
<b>Çalışma Gerilimi</b> Operating Voltage	100 - 265 V
<b>Işık Açısı</b> Light Angle	60° - 160°
<b>Koruma</b> IP Grade	IP67
<b>Kullanım Alanları</b> Mounting Options	Fabrika, depo, antrepo, Stadyum, Genel Aydınlatma Factory, storage, warehouse, Stadium, General Lighting
<b>Güç Seçenekleri</b> Power Options	10W - 20W - 50W - 80W - 100W-120W - 150W - 180W - 200W - 240W - 300W

## Ağır Sanayi Aydınlatmaları / Heavy Industrial Lighting

Pas



Montaj / Mounting

Boyutlar / Size

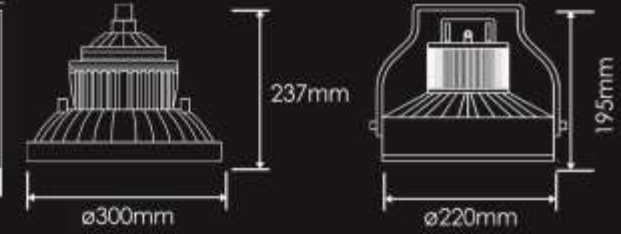

Teknik Bilgiler / Technical Data

<b>Işık Akısı / lm</b> Luminous flux	100 lm/W
<b>Işık Rengi</b> Lighting Color	2700 K 3000 K 4000 K 5000 K 6500 K
<b>Çalışma Gerilimi</b> Operating Voltage	100 - 265 V
<b>Işık Açısı</b> Light Angle	60° - 160°
<b>Koruma</b> IP Grade	IP67
<b>Kullanım Alanları</b> Mounting Options	Gaz Sahası, Petrol Sahası, Kimyasal Fabrika, Arıtma Tesisi Gas Field, Oil Field, Chemical Factory, Treatment Plant
<b>Güç Seçenekleri</b> Power Options	10W - 20W - 50W - 80W - 100W-120W - 150W - 180W - 200W - 240W - 300W
<b>Patlama Dayanımı</b> Explosion Proof Grade	Ex d IICt6 Gb



## Kanopi Aydınlatmaları / Canopy Lighting

Pkn



Montaj / Mounting

Boyutlar / Size

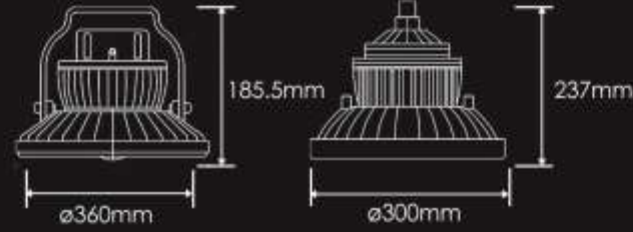

Teknik Bilgiler / Technical Data

<b>Işık Akısı / lm</b> Luminous flux	100 lm/W
<b>Işık Rengi</b> Lighting Color	 2700 K 3000 K 4000 K 5000 K 6500 K
<b>Çalışma Gerilimi</b> Operating Voltage	100 - 265 V
<b>Işık Açısı</b> Light Angle	60° - 160°
<b>Koruma</b> IP Grade	IP67
<b>Kullanım Alanları</b> Mounting Options	Alışveriş Merkezleri, Benzin istasyonları, Stadyum Shopping Center, Gas Stations, Stadium
<b>Güç Seçenekleri</b> Power Options	10W - 20W - 50W - 80W - 100W-120W - 150W - 180W - 200W - 240W - 300W
<b>Patlama Dayanımı</b> Explosion Proof Grade	Ex d IIC T6 Gb

## Taşınabilir Şarjlı Projektör / Portable Flood Light

Pts



Montaj / Mounting

Boyutlar / Size

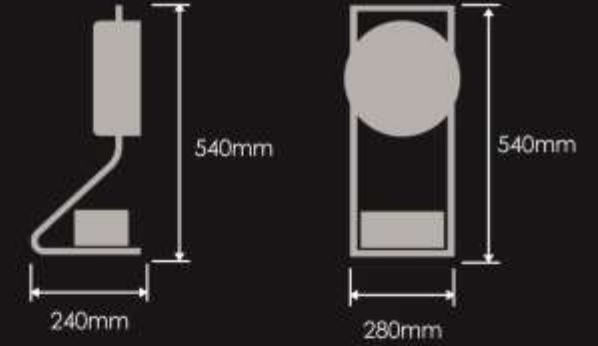

Teknik Bilgiler / Technical Data

<b>Işık Akısı / lm</b> Luminous flux	100 lm/W
<b>Işık Rengi</b> Lighting Color	 2700 K 3000 K 4000 K 5000 K 6500 K
<b>Çalışma Gerilimi</b> Operating Voltage	100 - 265 V
<b>Işık Açısı</b> Light Angle	60° - 160°
<b>Koruma</b> IP Grade	IP65
<b>Kullanım Alanları</b> Mounting Options	Diş Montaj, Acil Durum, Seyahat Outdoor Mounting, Emergency, Travel
<b>Güç Seçenekleri</b> Power Options	5W - 10W - 15W - 20W - 40W - 50W - 60W - 100W





## WallWasher - Projektör / Floodlight

Dr290



Ürün Detay / Product Detail

Boyutlar / Size

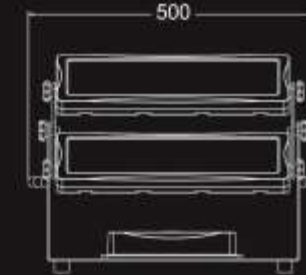

Teknik Bilgiler / Technical Data

<b>Led Adedi</b> Led Quantity	72	84
<b>Güç</b> Power	72 W	84 W
<b>Çalışma Gerilimi</b> Operating Voltage	AC 220V / DC 24V	
<b>Çalışma Sıcaklığı</b> Operating Temp.	-20°C +55°C	
<b>Led Açısı</b> Led Angle	15° - 25° - 45° - 60°	
<b>Işık Rengi</b> Lighting Color		
<b>Koruma</b> IP Grade	IP65	
<b>Kontrol Seçenekleri</b> Control Options	DMX512[1990]	
<b>Boyutlar</b> Size	500*380*290	



## WallWasher - Projektör / Floodlight

Dr290



Ürün Detay / Product Detail

Boyutlar / Size



Teknik Bilgiler / Technical Data

<b>Led Adedi</b> Led Quantity	36	42
<b>Güç</b> Power	36 W	42 W
<b>Çalışma Gerilimi</b> Operating Voltage	AC 220V / DC 24V	
<b>Çalışma Sıcaklığı</b> Operating Temp.	-20°C +55°C	
<b>Led Açısı</b> Led Angle	15° - 25° - 45° - 60°	
<b>Işık Rengi</b> Lighting Color	 2700 K 3000 K 4000 K 5000 K 6500 K RGB	
<b>Koruma</b> IP Grade	IP65	
<b>Kontrol Seçenekleri</b> Control Options	DMX512(1990)	
<b>Boyutlar</b> Size	400*160*284 mm	

## WallWasher - Projektör / Floodlight

Dr20648



Ürün Detay / Product Detail

Boyutlar / Size

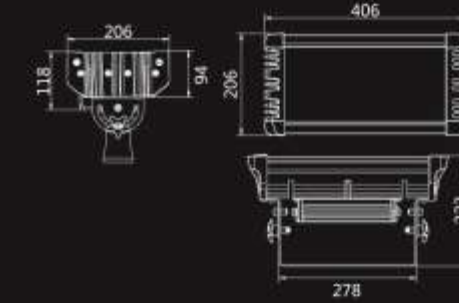

Teknik Bilgiler / Technical Data

<b>Led Adedi</b> Led Quantity	48
<b>Güç</b> Power	48 W
<b>Çalışma Gerilimi</b> Operating Voltage	AC 220V / DC 24V
<b>Çalışma Sıcaklığı</b> Operating Temp.	-20°C +55°C
<b>Led Açısı</b> Led Angle	15° - 25° - 45° - 60°
<b>Işık Rengi</b> Lighting Color	 2700 K 3000 K 4000 K 5000 K 6500 K RGB
<b>Koruma</b> IP Grade	IP65
<b>Kontrol Seçenekleri</b> Control Options	DMX512(1990)
<b>Boyutlar</b> Size	406*206*223 mm



## WallWasher - Projektör / Floodlight

Dr13072



Ürün Detay/ Product Detail

Boyutlar / Size

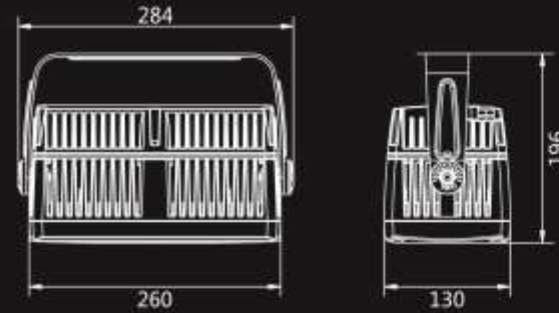

Teknik Bilgiler / Technical Data

<b>Led Adedi</b> Led Quantity	24
<b>Güç</b> Power	72 W
<b>Çalışma Gerilimi</b> Operating Voltage	AC 220V / DC 24V
<b>Çalışma Sıcaklığı</b> Operating Temp.	-20°C +55°C
<b>Led Açısı</b> Led Angle	15° - 25° - 45° - 60°
<b>Işık Rengi</b> Lighting Color	
<b>Koruma</b> IP Grade	IP65
<b>Kontrol Seçenekleri</b> Control Options	DMX512(1990)
<b>Boyutlar</b> Size	284*196*130 mm

150

## WallWasher - Projektör / Floodlight

Dr300

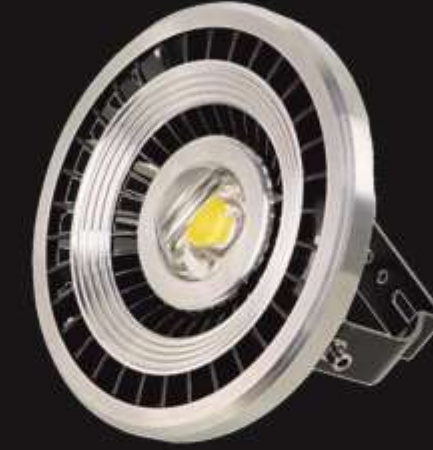

Ürün Detay/ Product Detail

Boyutlar / Size

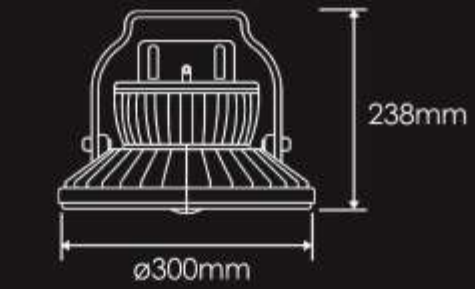

Teknik Bilgiler / Technical Data

<b>Led Adedi</b> Led Quantity	1
<b>Güç</b> Power	20W - 50W - 100W - 150W - 200W - 300 W
<b>Çalışma Gerilimi</b> Operating Voltage	AC 220V
<b>Çalışma Sıcaklığı</b> Operating Temp.	-20°C +50°C
<b>Led Açısı</b> Led Angle	30° - 45° - 60° - 90° - 120° - 160°
<b>Işık Rengi</b> Lighting Color	
<b>Koruma</b> IP Grade	IP67
<b>Kontrol Seçenekleri</b> Control Options	DMX512(1990)
<b>Boyutlar</b> Size	300*300*238 mm

151



## WallWasher

Ldr1072



Ürün Detay/ Product Detail

Boyutlar / Size

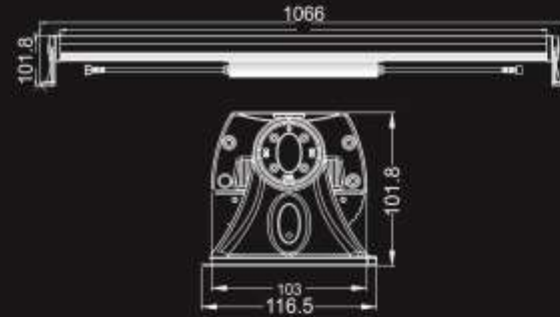

### Teknik Bilgiler / Technical Data

<b>Led Adedi</b> Led Quantity	72
<b>Power</b>	72 W
<b>Çalışma Gerilimi</b> Operating Voltage	AC 220V / DC 24V
<b>Çalışma Sıcaklığı</b> Operating Temp.	-20°C +55°C
<b>Led Açısı</b> Led Angle	15° - 30° - 20x60° - 45° - 60°
<b>Işık Rengi</b> Lighting Color	 2700 K 3000 K 4000 K 5000 K 6500 K RGB
<b>Koruma</b> IP Grade	IP65
<b>Kontrol Seçenekleri</b> Control Options	DMX512(1990)
<b>Boyutlar</b> Size	1066*90*150 mm

152

## WallWasher

Ldr2036



Ürün Detay/ Product Detail

Boyutlar / Size

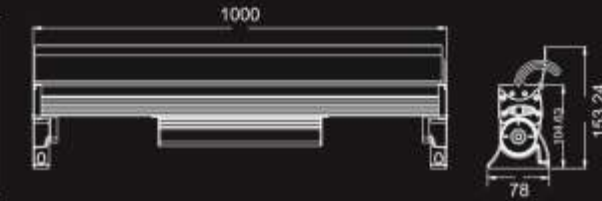

### Teknik Bilgiler / Technical Data

<b>Led Adedi</b> Led Quantity	36
<b>Power</b>	36 W
<b>Çalışma Gerilimi</b> Operating Voltage	AC 220V / DC 24V
<b>Çalışma Sıcaklığı</b> Operating Temp.	-20°C +55°C
<b>Led Açısı</b> Led Angle	15° - 30° - 20x60° - 45° - 60°
<b>Işık Rengi</b> Lighting Color	 2700 K 3000 K 4000 K 5000 K 6500 K RGB
<b>Koruma</b> IP Grade	IP65
<b>Kontrol Seçenekleri</b> Control Options	DMX512(1990)
<b>Boyutlar</b> Size	1000*90*150 mm

153

## WallWasher

Ldr30



Ürün Detay / Product Detail

Boyutlar / Size

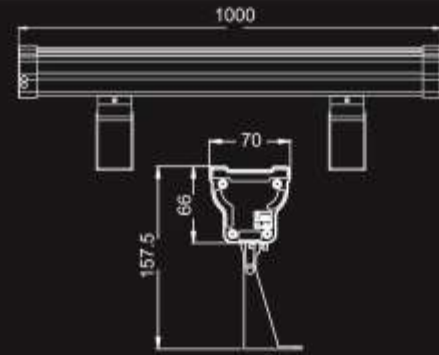

Teknik Bilgiler / Technical Data

<b>Led Adedi</b> Led Quantity	18	24	36
<b>Güç</b> Power	18 W	24 W	36 W
<b>Çalışma Gerilimi</b> Operating Voltage	AC 220V / AC 110V / DC 24V		
<b>Çalışma Sıcaklığı</b> Operating Temp.	-20°C +55°C		
<b>Led Açısı</b> Led Angle	15° - 30° - 45° - 60°		
<b>Işık Rengi</b> Lighting Color			
<b>Koruma</b> IP Grade	IP65		
<b>Kontrol Seçenekleri</b> Control Options	DMX512		
<b>Boyutlar</b> Size	1000*70*66 mm		

154

## WallWasher

Ldr40



Ürün Detay / Product Detail

Boyutlar / Size

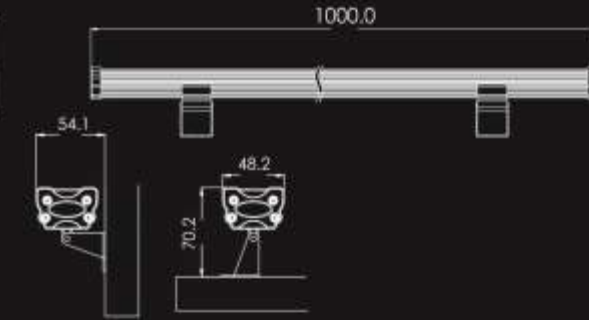

Teknik Bilgiler / Technical Data

<b>Led Adedi</b> Led Quantity	12	24
<b>Güç</b> Power	12W	24 W
<b>Çalışma Gerilimi</b> Operating Voltage	AC 220V / DC 24V	
<b>Çalışma Sıcaklığı</b> Operating Temp.	-20°C +55°C	
<b>Led Açısı</b> Led Angle	15° - 30° - 45° - 60°	
<b>Işık Rengi</b> Lighting Color		
<b>Koruma</b> IP Grade	IP65	
<b>Kontrol Seçenekleri</b> Control Options	DMX512	
<b>Boyutlar</b> Size	1000*70.2*54.1 mm	

155



## WallWasher

Ldi5018



Ürün Detay/ Product Detail



Boyutlar / Size

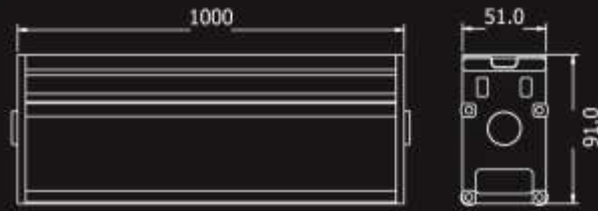

Teknik Bilgiler / Technical Data

<b>Led Adedi</b> Led Quantity	18
<b>Güç</b> Power	18 W
<b>Çalışma Gerilimi</b> Operating Voltage	AC 220V / AC 110V / DC 24V
<b>Çalışma Sıcaklığı</b> Operating Temp.	-20°C +55°C
<b>Led Açısı</b> Led Angle	15° - 30° - 45° - 60°
<b>Işık Rengi</b> Lighting Color	
<b>Koruma</b> IP Grade	IP65
<b>Kontrol Seçenekleri</b> Control Options	DMX512
<b>Boyutlar</b> Size	1000*91*51 mm

## WallWasher

Ldy30



Boyutlar / Size

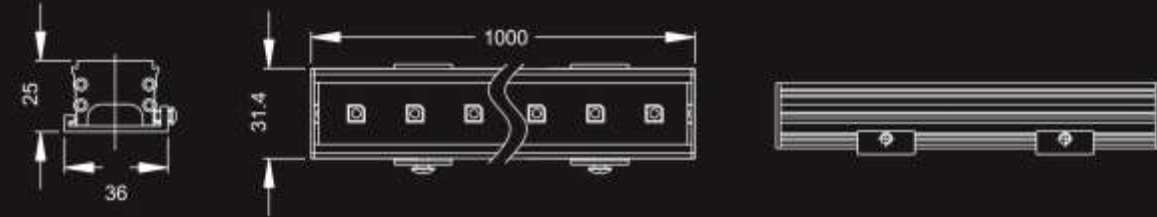

Teknik Bilgiler / Technical Data

<b>Led Adedi</b> Led Quantity	48 SMD	96 SMD
<b>Güç</b> Power	9.5 W	18.5 W
<b>Çalışma Gerilimi</b> Operating Voltage	DC 12V / DC 24V	
<b>Çalışma Sıcaklığı</b> Operating Temp.	-20°C +55°C	
<b>Led Açısı</b> Led Angle	15° - 30° - 45° - 60°	
<b>Işık Rengi</b> Lighting Color		
<b>Koruma</b> IP Grade	IP65	
<b>Kontrol Seçenekleri</b> Control Options	DMX512(1990)	
<b>Boyutlar</b> Size	1000*31.4*36 mm	

## WallWasher

Cpn



Cpn1030



Cpn1009

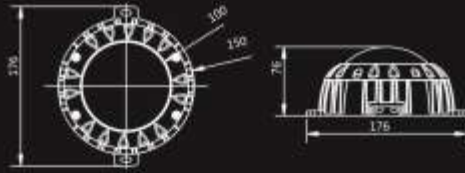

### Teknik Bilgiler / Technical Data

<b>Led Adedi</b> Led Quantity	30	9
<b>Güç</b> Power	9 W	9 W
<b>Boyutlar</b> Size	176*76 mm	176*76 mm
<b>Işık Rengi</b> Lighting Color	 RGB	
<b>Çalışma Gerilimi</b> Operating Voltage	DC 24V	AC 220V
<b>Çalışma Sıcaklığı</b> Operating Temp.	-20°C +50°C	-20°C +50°C
<b>Koruma</b> IP Grade	IP65	IP65

## WallWasher

Cpn



Cpn2003



Cpn3005

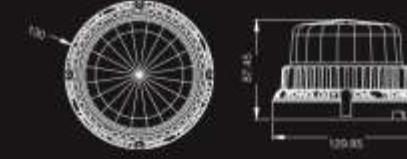
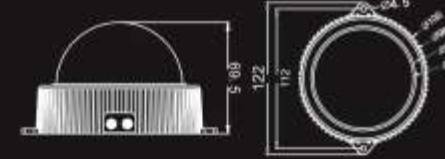

### Teknik Bilgiler / Technical Data

<b>Led Adedi</b> Led Quantity	36	72
<b>Güç</b> Power	2.5 W	5 W
<b>Boyutlar</b> Size	122*69.5 mm	129.85*87.45 mm
<b>Işık Rengi</b> Lighting Color	 RGB	
<b>Çalışma Gerilimi</b> Operating Voltage	AC 220 V / DC 24V	DC 24 V
<b>Çalışma Sıcaklığı</b> Operating Temp.	-20°C +55°C	-20°C +55°C
<b>Koruma</b> IP Grade	IP65	IP65



## WallWasher

Cpn



Cpn4004

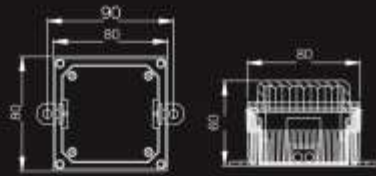

Cpn5002

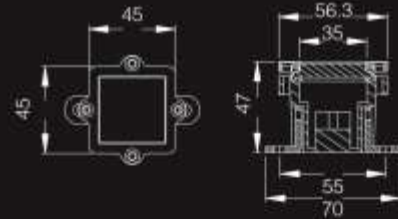

### Teknik Bilgiler / Technical Data

<b>Led Adedi</b> Led Quantity	18	4
<b>Güç</b> Power	3.5 W	1.5 W
<b>Boyutlar</b> Size	90*80*60 mm	45*45*47 mm
<b>Işık Rengi</b> Lighting Color	 RGB	
<b>Çalışma Gerilimi</b> Operating Voltage	AC 220V / DC 24V	AC 220V / DC 24V
<b>Çalışma Sıcaklığı</b> Operating Temp.	-20°C +55°C	-20°C +55°C
<b>Koruma</b> IP Grade	IP65	IP65

## WallWasher

Cpn



Cpn6001

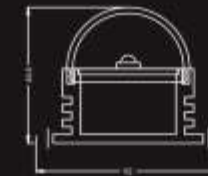

Cpn7002



Cpn8002

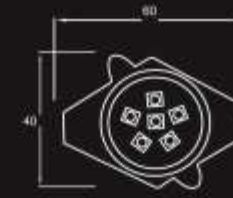

### Teknik Bilgiler / Technical Data

<b>Led Adedi</b> Led Quantity	3	24 / 36	6
<b>Güç</b> Power	1 W	2 W / 2.5 W	1.5 W
<b>Boyutlar</b> Size	122*69.5 mm	129.85 * 87.45 mm	60*40 mm
<b>Işık Rengi</b> Lighting Color	 RGB		
<b>Çalışma Gerilimi</b> Operating Voltage	DC 12V	DC 24V	DC 24V
<b>Çalışma Sıcaklığı</b> Operating Temp.	-20°C +55°C	-20°C +55°C	-20°C +55°C
<b>Koruma</b> IP Grade	IP65	IP65	IP65



ELEKTROSTATİK TOZ BOYA RENKLERİ / ELECTROSTATIC POWDER COATING SWATCH

RAL 1000	RAL 1001	RAL 1002	RAL 1003	RAL 1004	RAL 6005	RAL 6006	RAL 6007	RAL 6008	RAL 6009
RAL 1005	RAL 1006	RAL 1007	RAL 1011	RAL 1012	RAL 6010	RAL 6011	RAL 6012	RAL 6013	RAL 6014
RAL 1013	RAL 1014	RAL 1015	RAL 1016	RAL 1017	RAL 6015	RAL 6016	RAL 6017	RAL 6018	RAL 6019
RAL 1018	RAL 1019	RAL 1020	RAL 1021	RAL 1023	RAL 6020	RAL 6021	RAL 6022	RAL 6024	RAL 6025
RAL 1024	RAL 1027	RAL 1028	RAL 1032	RAL 1033	RAL 6026	RAL 6027	RAL 6028	RAL 6029	RAL 6032
RAL 1034	RAL 1037	RAL 2000	RAL 2001	RAL 2002	RAL 6033	RAL 6034	RAL 7000	RAL 7001	RAL 7002
RAL 2003	RAL 2004	RAL 2008	RAL 2009	RAL 2010	RAL 7003	RAL 7004	RAL 7005	RAL 7006	RAL 7008
RAL 2011	RAL 2012	RAL 3000	RAL 3001	RAL 3002	RAL 7009	RAL 7010	RAL 7011	RAL 7012	RAL 7013
RAL 3003	RAL 3004	RAL 3005	RAL 3007	RAL 3009	RAL 7015	RAL 7016	RAL 7021	RAL 7022	RAL 7023
RAL 3011	RAL 3012	RAL 3013	RAL 3014	RAL 3015	RAL 7024	RAL 7026	RAL 7030	RAL 7031	RAL 7032
RAL 3016	RAL 3017	RAL 3018	RAL 3020	RAL 3022	RAL 7033	RAL 7034	RAL 7035	RAL 7036	RAL 7037
RAL 3027	RAL 3031	RAL 4001	RAL 4002	RAL 4003	RAL 7038	RAL 7039	RAL 7040	RAL 7042	RAL 7043
RAL 4004	RAL 4005	RAL 4006	RAL 4007	RAL 4008	RAL 7044	RAL 7045	RAL 7046	RAL 7047	RAL 8000
RAL 4009	RAL 4010	RAL 5000	RAL 5001	RAL 5002	RAL 8001	RAL 8002	RAL 8003	RAL 8004	RAL 8007
RAL 5003	RAL 5004	RAL 5005	RAL 5007	RAL 5008	RAL 8008	RAL 8011	RAL 8012	RAL 8014	RAL 8015
RAL 5009	RAL 5010	RAL 5011	RAL 5012	RAL 5013	RAL 8016	RAL 8017	RAL 8019	RAL 8022	RAL 8023
RAL 5014	RAL 5015	RAL 5017	RAL 5018	RAL 5019	RAL 8024	RAL 8025	RAL 8028	RAL 9001	RAL 9002
RAL 5020	RAL 5021	RAL 5022	RAL 5023	RAL 5024	RAL 9003	RAL 9004	RAL 9005	RAL 9006	RAL 9007
RAL 6000	RAL 6001	RAL 6002	RAL 6003	RAL 6004	RAL 9010	RAL 9011	RAL 9016	RAL 9017	RAL 9018

AHŞAP DESEN SEÇENEKLERİ / WOOD PATTERNS

N.KAYIN 1	N.KAYIN 4	ARMUT	MAUN	WENGE	NOSTALJİ
AK AĞAÇ	KOYU KIRAZ	BERGAMA	VENEDİK CEVİZİ	YENİCE MEŞE	IHLARA
HUŞ	TEAK	BOSFOR	ZEYRANO	LADİN	AFRİKA CEVİZİ
DUMAN MEŞE	MARBELLA KIRAZ	ABANOZ	NAPOLYON KIRAZI	LATİN CEVİZ	ELMA
ANADOLU CEVİZİ	BAMBU	SAMBA	METALİK CEVİZ	BEYAZ ERİK	MİLAS
AK MEŞE	DOĞAL HUŞ	AÇIK ZEBRANO	CORDOBA	CARMEN	ATLANTİS
İTALYAN CEVİZ	BEYAZ ALPİ	NATURAL MEŞE	PALİSENDER	MILANO	TOSCANA
VENEZIA	KARYA	ARKADYA	ARKADYA DARK	ANTRASİT MEŞE	BIANCO
NEVADA	HAVANA	AÇIK SAFİR	KOYU SAFİR	SAHARA	AKASYA
PASİFİK CEVİZ	BAROK	ANTİK BEYAZ	ALASKA	SAN REMO	LEFKAS MEŞE



ELOKSAL SEÇENEKLERİ / ELECTRO ANODIZING SWACH



KROMAJ  
CHROMED



SATİNE PASLANMAZ  
SATIN STAINLESS



SATİNE ANTRASİT  
SATIN ANTHRACITE



SATİNE ALTIN  
SATIN GOLD



SATİNE SİYAH  
SATIN BLACK



SİYAH  
BLACK



ALTIN  
GOLD



NATUREL  
NATURAL



KAHVE  
BROWN



ŞAMPANYA  
CHAMPAGNE



PEMBE  
PINK



KIRMIZI  
RED



YEŞİL  
GREEN



MAVİ  
BLUE



MOR  
PURPLE

